



Post Office Box 97
Benton Harbor, Michigan
Ph: 269/926-6171
Fax: 269/925-8288

PART NUMBER:

STD122D

REVISION:

A

Product Specifications

Model Number	MAX. PRESS.		MAX. SPEED	HP	kW	Net Wt.	
	bar.	PSI				lbs.	kg
4AM-NRV-22BNLP	5.6	80	2,000 RPM	1.05	.77	7	3.2
4AM-NRV-54ANLP	5.5	80	2,000 RPM	1.05	.77	7	3.2

SOUND LEVEL 87 dB(A) MAX.
 NORMAL AMBIENT +1°C. - 120°C.
 RELATIVE HUMIDITY 0% - 100%
 ENVIRONMENT HAZARDOUS AMBIENT COMBUSTIBLE
GAS AND DUST +1° TO +40°C

CONFORMS TO EUROPEAN STANDARD EN13463-1
 NON-ELECTRICAL EQUIPMENT FOR EXPLOSIVE
 ATMOSPHERES GROUP II CAT 2 (GAS & DUST),
 PROTECTED BY CONSTRUCTION (SURFACE TEMP. RATED 135°C).

NOTES:

1. CORROSION RESISTANT ROTOR ASSEMBLY, BODY & END PLATES.
2. UNIVERSAL VANE MATERIAL FOR OPERATING WITH OR WITHOUT LUBRICATION.
3. TECHNICAL DATA SUBJECT TO CHANGE WITHOUT NOTICE

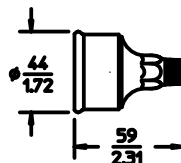
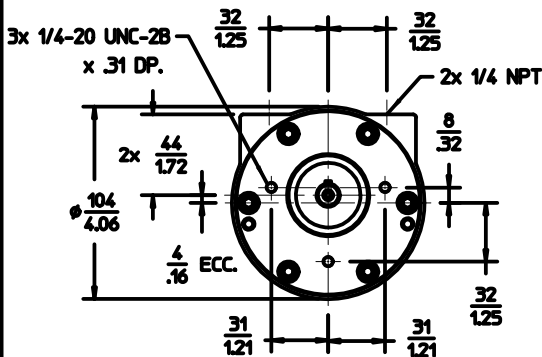
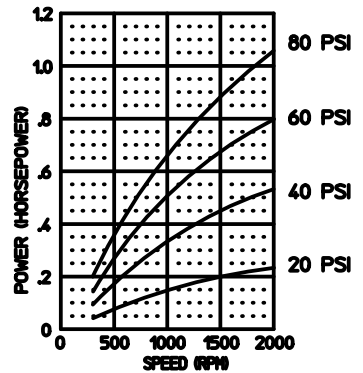
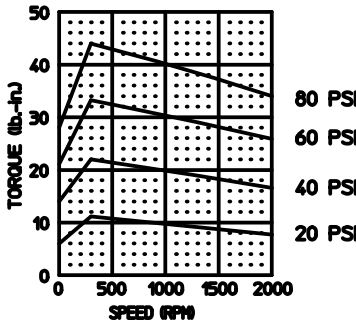
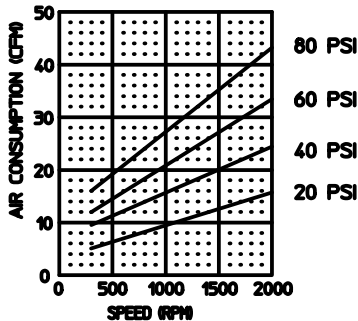
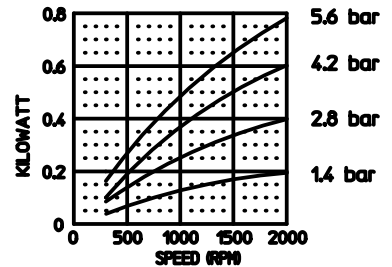
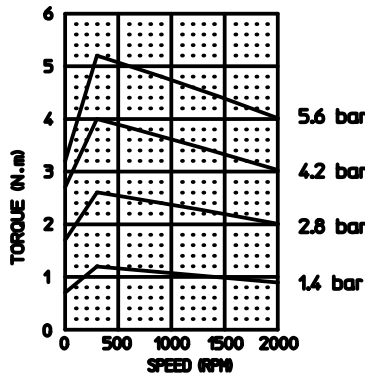
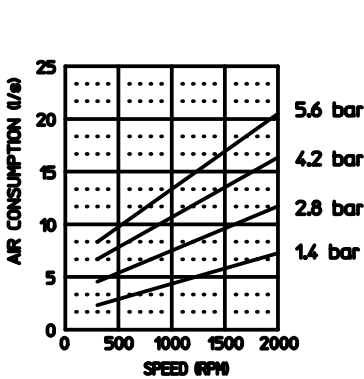

MUFFLER ASM.
(SHIPPED UNATTACHED)

