

Herrug
Expert in Seals

高品质密封件供应商



上海赫鲁格精密橡胶有限公司
Shanghai Herrug Precision Rubber.Co.,Ltd



CONTENTS



O型圈概述 Summary	01
橡胶物性表 Property list	02
密封机理 Seal mechanism	03
O型圈尺寸表 O-rings Size List	04
O型圈公差表 Tolerance table	13
管接头密封圈 Pipe joint seals	13
组合垫规格表 Combination of gasket specifications	14
储存指导 Store both instructions	15
定制件产品 Custom Molded Parts	16

概 述

O型圈，就是一种截面为圆形的橡胶密封圈，故称其为O型密封圈，简称O型圈。橡胶O型圈是一种简单、常见、低成本的小零件，它被广泛应用于各行各业许许多多工业部件中，看起来不显眼，却是系统不可缺少的一分子，是经常起着重要作用的精密零部件。



使用O型圈有如下的优点:

- 1) 设计简单，结构小巧，装拆方便
- 2) 密封性能良好，用作静密封时几乎可以做到无泄露；
- 3) 运动摩擦阻力很小，对于压力交变的场合也能适应；
- 4) 尺寸已实现标准化，系列化，价格便宜，便于使用和外购。

通用的O型密封圈在航空航天，石油化工，煤炭，电力，冶金，交通运输，机械制造，汽车，电子，水暖卫浴，小家电等等行业的应用越来越广泛，已成为各种行业中的基础配件。

世界上主要的工业强国已经对O型圈的尺寸进行了标准化，形成了各自的国家标准，常用有美国标准(AS-568)；日本标准(JIS240)；德国标准(DIN3771)；英国标准(BS1806, BS4518)；法国标准(R)；国际标准(ISO3601-1)；我国标准是(GB3452.1-92)。

材 料:









用于O型圈的一种主要材料就是合成橡胶。合成橡胶是由石化工业所产生的副产品，依不同需求，合成不同物性的生胶料。常用的如:SBR、NBR、EPDM、BR、IIR、CR、Q、FKM等。但因合成方式的差异，同类胶料可分出数种不同的生胶，又经由配方的设定，任何类型胶料，均可变化成千百种符合制品需求的生胶料。合成橡胶具有良好的物理性能，如回弹性、绝缘性、隔水性及可塑性等，又有良好的化学性能相容性，如耐油、耐酸、耐碱、耐溶剂等。

产品制造商和最终用户都希望密封系统能无泄露运行，并具有较长的使用寿命。可靠性对于有效的降低维护费用是非常关键的。密封效果的好坏，除了密封系统的结构设计、沟槽机加工的水平外，还要充分了解各种不同合成橡胶的性能差异，以及合理选用正确的材料。

物性表

◎特佳 ○佳 △普通 ×差

材料名称 物性要求	物性等级	丁腈橡胶	丁腈橡胶	氯化丁腈橡胶	羧基丁腈橡胶	三元乙丙橡胶	硅矽橡胶	氯丁橡胶	氟素橡胶	四丙氟橡胶	氟硅橡胶	全氟橡胶	聚四氟乙烯	聚氨酯	氟醚橡胶	天然橡胶	丁苯橡胶	丁基橡胶	丙烯酸酯
		NBR (N)	NBR (H)	XNBR (X)	EPDM (E)	VMQ (S)	CR (C)	FKM (V)	AFLAS (L)	FVMQ (F)	FFKM (K)	PTFE (T)	PU (U)	ECO (O)	NR (R)	SBR (B)	IIR (I)	ACR (A)	
抗臭性	△	○	○	○	○	○	○	○	○	○	○	○	○	○	○	×	×	○	○
耐候性	○	○	○	○	○	○	○	○	○	○	○	○	○	○	○	×	△	○	○
耐热性	120℃	150℃	150℃	150℃	220℃	120℃	200℃	175℃	320℃	280℃	90℃	135℃	90℃	110℃	120℃	150℃			
耐化学药品性	○△	○	○	○	○	○△	○	○△	○	○	○	○	○	○	○	×	△	○	×
耐油性	○	○	○	×	○△	○△	○	○△	○	○	○	○	○	○	○	×	×	×	○
密水性	○	○	○	○	○	○	○	○	○	○	○	○	○	○	○	○	○	○	○
耐寒性	-40℃	-40℃	-35℃	-50℃	-70℃	-40℃	-20℃	-30℃	-20℃	-60℃	-100℃	-40℃	-35℃	-60℃	-40℃	-50℃	-25℃		
耐磨损性	○	○	○	○	×	○	○	○	○	○	○	○	○	○	○	○	○	○	△
抗变形性	○	○	△	○	○	△	○	○	○	○	×	○	○	×	○	○	○	○	△
耐酸性	△	○	○	○	△	○	○	○	○	○	○	○	○	×	○△	○△	○△	○△	△×
耐碱性	○	○	○	○	△	○	○	○	○	○	○	○	○	×	○	△	○	○	×
张力强度	○	○	○	○	×	○	○	○	○	○	○	○	○	○	○	○	○	○	△
耐水蒸气性	×	○△	○△	○	○△	△	○△	○	○	○	○	○	○	×	○△	×	×	○△	×
抗燃性	×	×	△	×	△×	○	○	△×	○	△×	△	△	△	△	△×	×	×	△×	△×
存储稳定性 (Y=年)	5-10Y	5-10Y	5-10Y	5-10Y	ABT20Y	5-10Y	ABT20Y	5-10Y	ABT20Y	ABT20Y	ABT20Y	ABT20Y	ABT20Y	ABT20Y	5-10Y	3-5Y	5-10Y	5-10Y	ABT20Y

常用材料参考色	标准色号 (PANTONE)
	187C 红色
	1665C 橙色
	7404U 黄色
	3298C 绿色
	280C 蓝色
	431C 灰色
	2665U 紫色
	4975C 棕色
	Warm gray 1C 牛奶色

密封机理

橡胶密封圈可以被想象成为不可压缩的、具有很高表面张力的“高粘度流体”。不论是受周围机械结构的机械压力作用、还是受流体传递的压力作用，这种“高粘度流体”在沟槽中“流动”，形成“零间隙”，或者说阻止了被其密封的流体的流动。橡胶的弹性补偿了制造和配合公差，其材料内部的弹性记忆是维持密封的重要条件。

常见泄漏形式

1. 穿漏

通过密封面间隙的泄漏。在压力差的作用下，通过宏观和微观的缝隙的泄漏，此为单向泄漏。

2. 渗漏

在压力差的作用下，介质通过密封件材料的毛细管的泄漏。渗漏也是单向分子泄漏流动。

3. 扩散

在浓度差的作用下，介质通过密封间隙或密封材料毛细管产生的物质传递，叫扩散。扩散过程是双向的。

常见弹性体使用温度范围

该温度范围仅使用在与各种橡胶所相容的介质中

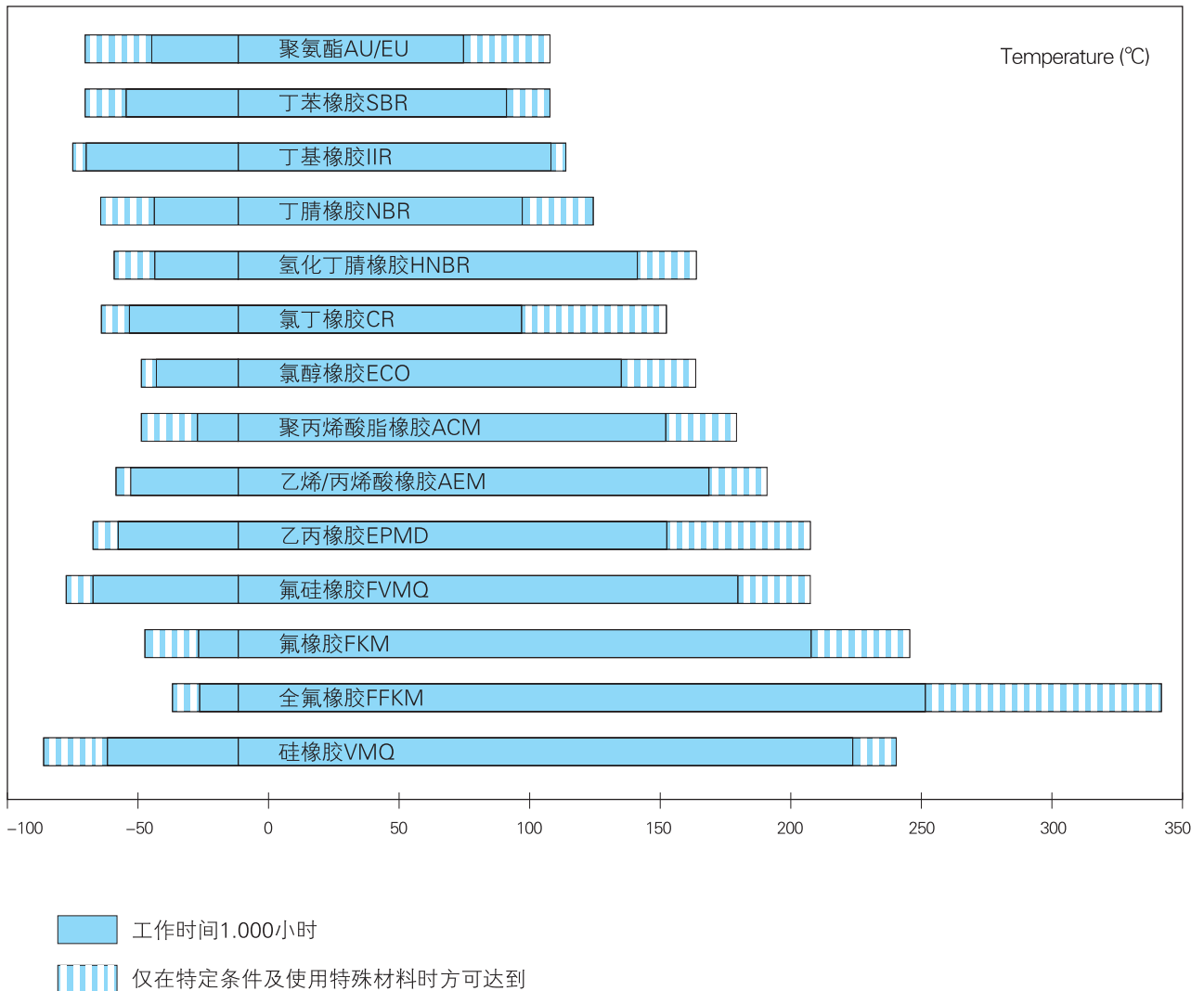

O型圈 (O-Ring):

代码: A=美标AS568、C=中标、P.G=日标、M=公制尺寸
生产胶种: 材料物性表中的所有胶种。
生产尺寸: 直径4000mm一下之任何规格。

星型圈 (QUAD-Ring/X-Ring):

星型圈是四唇口密封件, 它在O型基础上性能又做了改进和提高, 其标准尺寸完全与美国AS568标准的O型圈相同, 可替代大部分O型圈场合。
尺寸mm(内径*线径)

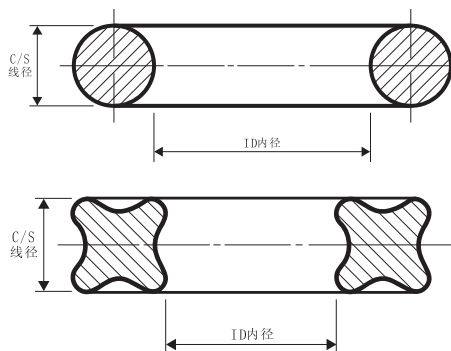

尺寸 mm (内径*线径)	代 码	尺寸 mm (内径*线径)	代 码	尺寸 mm (内径*线径)	代 码	尺寸 mm (内径*线径)	代 码
0.50*0.50	M	3.68*1.78	A-007	6.07*1.63	A-902	8.80*1.90	P9
0.50*1.00	M	3.75*1.80	C	6.07*1.78	A-010	8.92*1.83	A-904
0.60*0.50	M	3.80*1.90	P4	6.30*1.80	C	9.00*0.50	M
0.70*0.50	M	4.00*0.50	M	6.50*1.00	M	9.00*1.00	M
0.74*1.02	A-001	4.00*1.00	M	6.50*1.50	M	9.00*1.50	M
0.80*0.50	M	4.00*1.50	M	6.50*2.00	M	9.00*1.80	C
0.80*1.00	M	4.00*1.80	C	6.50*3.00	M	9.00*2.00	M
1.00*0.50	M	4.00*2.00	M	6.70*1.80	C	9.00*2.50	M
1.00*1.00	M	4.00*2.50	M	6.80*1.90	P7	9.00*2.65	C
1.00*2.00	M	4.00*3.00	M	6.90*1.80	C	9.00*3.00	M
1.07*1.27	A-002	4.00*4.00	M	7.00*0.50	M	9.00*4.00	M
1.24*2.62	A-102	4.34*3.53	A-201	7.00*1.00	M	9.00*4.50	M
1.42*1.53	A-003	4.42*2.62	A-106	7.00*1.50	M	9.12*3.53	A-204
1.50*0.50	M	4.47*1.78	A-008	7.00*2.00	M	9.19*2.62	A-110
1.50*1.00	M	4.50*1.00	M	7.00*2.50	M	9.25*1.78	A-012
1.50*1.50	M	4.50*1.50	M	7.00*3.00	M	9.50*1.00	M
1.50*2.00	M	4.50*1.80	C	7.10*1.80	C	9.50*1.80	C
1.78*1.78	A-004	4.50*2.00	M	7.10*2.65	C	9.50*2.00	M
1.80*1.80	C	4.70*1.42	A-901	7.50*1.80	C	9.50*2.65	C
2.00*0.50	M	4.80*1.90	P5	7.50*2.00	M	9.80*1.90	P10
2.00*1.00	M	4.87*1.80	C	7.50*2.50	M	9.80*2.40	P10A
2.00*1.50	M	5.00*0.50	M	7.50*2.65	C	10.00*1.00	M
2.00*1.80	C	5.00*1.00	M	7.52*3.53	A-203	10.00*1.50	M
2.00*2.00	M	5.00*1.50	M	7.60*2.62	A-109	10.00*1.80	C
2.06*2.62	A-103	5.00*1.80	C	7.65*1.63	A-903	10.00*2.00	M
2.24*1.08	C	5.00*2.00	M	7.65*1.78	A-011	10.00*2.50	M
2.50*0.50	M	5.00*2.50	M	7.80*1.90	P8	10.00*2.65	C
2.50*1.00	M	5.00*3.00	M	8.00*0.50	M	10.00*3.00	M
2.50*1.50	M	5.00*5.00	M	8.00*1.00	M	10.00*4.00	M
2.50*1.80	C	5.15*1.80	C	8.00*1.50	M	10.00*5.00	M
2.57*1.78	A-005	5.23*2.62	A-107	8.00*1.80	C	10.46*5.33	A-309
2.80*1.80	C	5.28*1.78	A-009	8.00*2.00	M	10.50*1.50	M
2.80*1.90	P3	5.30*1.80	C	8.00*2.50	M	10.52*1.83	A-905
2.84*2.62	A-104	5.50*1.50	M	8.00*2.65	C	10.60*1.80	C
2.90*1.78	A-006	5.60*1.80	C	8.00*3.00	M	10.60*2.65	C
3.00*0.50	M	5.80*1.90	P6	8.00*4.00	M	10.69*3.53	A-205
3.00*1.00	M	5.94*3.53	A-202	8.00*5.00	M	10.77*2.62	A-111
3.00*1.50	M	6.00*1.00	M	8.50*0.50	M	10.80*2.40	P11
3.00*2.00	M	6.00*1.50	M	8.50*1.00	M	10.82*1.78	A-013
3.00*3.00	M	6.00*1.80	C	8.50*1.50	M	11.00*1.00	M
3.15*1.80	C	6.00*2.00	M	8.50*1.80	C	11.00*1.50	M
3.50*1.00	M	6.00*2.50	M	8.50*2.00	M	11.00*2.00	M
3.50*1.50	M	6.00*3.00	M	8.50*2.50	M	11.00*2.40	P11.2
3.50*2.00	M	6.00*5.00	M	8.50*2.65	C	11.00*2.50	M
3.55*1.80	C	6.00*6.00	M	8.75*1.80	C	11.00*3.00	M
3.63*2.62	A-105	6.02*2.62	A-108	8.75*2.65	C	11.00*4.00	M

尺寸 mm (内径*线径)	代 码	尺寸 mm (内径*线径)	代 码	尺寸 mm (内径*线径)	代 码	尺寸 mm (内径*线径)	代 码
11.20*1.08	C	14.50*0.60	M	18.00*1.00	M	21.00*3.00	M
11.20*2.65	C	14.50*0.70	M	18.00*1.50	M	21.00*3.50	M
11.50*1.50	M	14.50*0.80	M	18.00*1.80	C	21.00*4.00	M
11.50*2.00	M	14.80*2.40	P15	18.00*2.00	M	21.20*1.80	C
11.50*2.50	M	15.00*0.50	M	18.00*2.50	M	21.20*2.65	C
11.50*3.00	M	15.00*1.00	M	18.00*2.65	C	21.20*3.55	C
11.80*1.80	C	15.00*1.50	M	18.00*3.00	M	21.50*0.50	M
11.80*2.40	P12	15.00*1.80	C	18.00*3.50	M	21.59*5.33	A-316
11.80*2.65	C	15.00*2.00	M	18.00*3.55	C	21.70*3.50	P22A
11.89*1.98	A-906	15.00*2.50	M	18.00*5.00	M	21.80*2.40	P22
12.00*1.00	M	15.00*2.65	C	18.00*6.00	M	21.80*3.10	G22
12.00*1.50	M	15.00*3.00	M	18.42*5.33	A-314	21.82*3.53	A-212
12.00*2.00	M	15.00*3.50	M	18.50*0.50	M	21.89*2.62	A-118
12.00*2.50	M	15.00*4.00	M	18.64*3.53	A-210	21.92*2.95	A-911
12.00*3.00	M	15.00*5.00	M	18.72*2.62	A-116	21.95*1.78	A-020
12.00*3.50	M	15.24*5.33	A-312	18.77*1.78	A-018	22.00*1.00	M
12.00*4.00	M	15.47*3.53	A-208	19.00*0.50	M	22.00*1.50	M
12.00*5.00	M	15.50*0.50	M	19.00*1.00	M	22.00*2.00	M
12.07*5.33	A-310	15.54*2.62	A-114	19.00*1.50	M	22.00*2.50	M
12.29*3.53	A-206	15.60*1.78	A-016	19.00*1.80	C	22.00*3.00	M
12.30*2.40	P12.5	15.80*2.40	M	19.00*2.00	M	22.00*4.00	M
12.37*2.62	A-112	16.00*0.50	M	19.00*2.50	M	22.00*5.00	M
12.42*1.78	A-014	16.00*1.00	M	19.00*2.65	C	22.10*3.50	P22.4
12.50*1.50	M	16.00*1.50	C	19.00*3.55	C	22.40*1.80	C
12.50*1.80	C	16.00*1.80	M	19.00*4.00	M	22.40*2.65	C
12.50*2.00	M	16.00*2.00	M	19.18*2.46	A-910	22.40*3.55	C
12.50*2.50	M	16.00*2.50	C	19.40*3.10	G20	22.50*0.50	M
12.50*2.65	C	16.00*2.65	M	19.80*2.40	P20	23.00*0.50	M
13.00*1.00	M	16.00*3.00	M	19.99*5.33	A-315	23.00*1.00	M
13.00*1.50	M	16.00*4.00	M	20.00*0.50	M	23.00*1.50	M
13.00*2.00	M	16.00*4.50	M	20.00*1.00	M	23.00*2.00	M
13.00*2.50	M	16.00*5.00	M	20.00*1.50	M	23.00*2.50	M
13.00*3.00	M	16.36*2.21	A-908	20.00*1.80	C	23.00*3.00	M
13.20*1.80	C	16.50*0.50	M	20.00*2.00	M	23.00*4.00	M
13.20*2.65	C	16.81*5.33	A-313	20.00*2.50	M	23.00*5.00	M
13.47*2.08	A-907	17.00*0.50	M	20.00*2.65	C	23.16*5.33	A-317
13.64*5.33	A-311	17.00*1.00	M	20.00*3.00	M	23.39*3.53	A-213
13.80*2.40	P14	17.00*1.50	M	20.00*3.55	C	23.47*2.62	A-119
13.87*3.53	A-207	17.00*1.80	C	20.00*4.00	M	23.47*2.95	A-912
13.94*2.62	A-113	17.00*2.00	M	20.00*4.50	M	23.50*0.50	M
14.00*1.00	M	17.00*2.50	M	20.00*6.00	M	23.52*1.78	A-021
14.00*1.50	M	17.00*2.65	C	20.22*3.53	A-211	23.60*1.80	C
14.00*1.78	A-105	17.00*4.00	M	20.29*2.62	A-117	23.60*2.65	C
14.00*1.80	C	17.04*3.53	A-209	20.35*1.78	A-019	23.60*3.55	C
14.00*2.00	M	17.12*2.62	A-115	20.50*0.50	M	23.70*3.50	P24
14.00*2.50	M	17.17*1.78	A-017	20.80*2.40	P21	24.00*0.50	M
14.00*3.00	C	17.50*0.50	M	21.00*0.50	M	24.00*1.00	M
14.00*4.00	M	17.50*2.00	M	21.00*1.00	M	24.00*1.50	M
14.50*4.00	M	17.80*2.40	P18	21.00*1.50	M	24.00*2.00	M
14.50*0.40	M	17.94*2.46	A-909	21.00*2.00	M	24.00*2.50	M
14.50*0.50	M	18.00*0.50	M	21.00*2.50	M	24.00*3.00	M

尺寸 mm (内径*线径)	代 码	尺寸 mm (内径*线径)	代 码	尺寸 mm (内径*线径)	代 码	尺寸 mm (内径*线径)	代 码
24.00*3.50	M	28.00*1.50	M	32.00*0.50	M	37.00*2.50	M
24.00*4.00	M	28.00*1.80	C	32.00*1.50	M	37.00*3.00	M
24.00*5.50	M	28.00*2.00	M	32.00*2.00	M	37.00*4.00	M
24.40*3.10	G25	28.00*2.50	M	32.00*2.50	M	37.46*3.00	A-920
24.50*0.50	M	28.00*2.65	C	32.00*3.00	M	37.47*5.33	A-325
24.70*3.50	P25	28.00*3.00	M	32.00*4.00	M	37.47*6.99	A-401
24.77*5.33	A-318	28.00*3.55	C	32.00*5.00	M	37.50*1.80	C
24.99*3.53	A-214	28.00*4.00	M	32.50*1.80	C	37.50*2.65	C
25.00*1.50	M	28.00*5.00	M	32.00*2.60	C	37.50*3.55	C
25.00*1.80	C	28.17*3.53	A-216	32.50*3.55	C	37.69*3.53	A-222
25.00*2.00	M	28.24*2.62	A-122	32.69*5.33	A-323	37.70*3.50	P38
25.00*2.50	M	28.30*1.78	A-024	32.92*3.53	A-219	37.77*2.62	A-128
25.00*2.65	C	28.50*0.50	M	32.99*2.62	A-125	37.82*1.78	A-029
25.00*3.00	M	28.70*3.50	P29	33.00*1.50	M	38.00*2.00	M
25.00*3.53	A-214	29.00*0.50	M	33.00*2.00	M	38.00*2.50	M
25.00*3.55	C	29.00*2.50	M	33.00*2.50	M	38.00*3.00	M
25.00*4.00	M	29.00*5.00	M	33.00*3.00	M	38.00*4.00	M
25.00*5.00	M	29.20*3.50	P29.5	33.05*1.78	A-027	38.00*4.50	M
25.00*6.00	M	29.40*3.10	G30	33.50*1.80	C	38.00*7.00	M
25.04*2.95	A-913	29.50*0.40	M	33.50*2.65	C	38.70*1.80	C
25.07*2.62	A-120	29.50*0.50	M	33.50*3.65	C	38.70*2.65	C
25.12*1.78	A-022	29.50*0.60	M	33.70*3.50	P34	38.70*3.50	P39
25.20*3.50	P25.5	29.50*0.70	M	34.00*2.00	M	38.70*3.55	C
25.50*0.50	M	29.51*5.33	A-321	34.00*4.00	M	39.00*2.00	M
25.70*3.50	P26	29.70*3.50	P30	34.29*5.33	A-324	39.00*2.50	M
25.80*1.80	C	29.74*3.53	A-217	34.40*3.10	G35	39.00*3.00	M
25.80*2.65	C	29.75*2.95	A-916	34.42*2.95	A-918	39.34*2.62	A-129
25.80*3.55	C	29.82*2.62	A-123	34.50*1.80	C	39.40*3.10	G40
26.00*0.50	M	29.87*1.78	A-025	34.50*2.65	C	39.70*3.50	P40
26.00*1.00	M	30.00*0.50	M	34.50*3.55	C	40.00*1.80	C
26.00*1.50	M	30.00*1.00	M	34.52*3.53	A-220	40.00*2.00	M
26.00*2.00	M	30.00*1.50	M	34.59*2.62	A-126	40.00*2.50	M
26.00*3.00	M	30.00*1.80	C	34.65*1.78	A-028	40.00*3.00	M
26.00*3.50	M	30.00*2.00	M	34.70*3.50	P35	40.00*3.50	M
26.00*4.00	M	30.00*2.50	M	35.00*1.50	M	40.00*3.55	C
26.00*5.00	M	30.00*2.65	C	35.00*2.00	M	40.00*4.00	M
26.34*5.33	A-319	30.00*3.00	M	35.00*2.50	M	40.00*5.00	M
26.50*0.50	M	30.00*3.55	C	35.00*3.00	M	40.00*5.30	C
26.50*1.80	C	30.00*4.00	M	35.00*4.00	M	40.00*5.50	M
26.50*2.65	C	30.00*5.00	M	35.00*5.00	M	40.00*6.00	M
26.50*3.55	C	30.00*6.00	M	35.20*3.50	P35.5	40.64*5.33	A-326
26.57*3.53	A-215	30.50*0.50	M	35.50*1.80	C	40.70*3.50	P41
26.60*2.95	A-914	30.70*3.50	P31	35.50*2.65	C	40.87*3.53	A-223
26.64*2.62	A-121	31.00*0.50	M	35.50*3.55	C	40.94*2.62	A-130
26.70*1.78	A-023	31.00*2.00	M	35.70*3.50	P36	41.00*1.78	A-030
27.00*0.50	M	31.00*2.50	M	36.00*1.50	M	41.00*4.00	M
27.00*1.50	M	31.00*3.00	M	36.00*2.00	M	41.20*1.80	C
27.00*2.00	M	31.12*5.33	A-322	36.00*2.50	M	41.20*2.65	C
27.00*2.50	M	31.20*3.50	P31.5	36.00*3.00	M	41.20*3.55	C
27.00*3.00	M	31.34*3.53	A-218	36.00*4.00	M	41.20*5.30	C
27.00*4.00	M	31.42*2.62	A-124	36.00*5.00	M	41.70*3.50	P42
27.00*5.00	M	31.47*1.78	A-026	36.09*3.53	A-221	42.00*1.00	M
27.50*0.50	M	31.50*0.50	M	36.17*2.62	A-127	42.00*2.00	M
27.70*3.50	P28	31.50*1.80	C	36.50*1.80	C	42.00*2.50	M
27.94*5.33	A-320	31.50*2.65	C	36.50*2.65	C	42.00*3.00	M
28.00*0.50	M	31.50*3.55	C	36.50*3.50	C	42.00*3.50	M
28.00*1.00	M	31.70*3.50	P32	37.00*2.00	M	42.00*4.00	M

尺寸 mm (内径*线径)	代 码	尺寸 mm (内径*线径)	代 码	尺寸 mm (内径*线径)	代 码	尺寸 mm (内径*线径)	代 码
42.00*5.00	M	47.22*3.53	A-225	53.00*1.50	M	58.42*2.62	A-141
42.50*1.80	C	47.29*2.62	A-134	53.00*2.00	M	59.00*3.00	M
42.50*2.65	C	47.35*1.78	A-032	53.00*2.50	M	59.36*3.00	A-932
42.50*3.55	M	47.50*1.80	C	53.00*2.65	C	59.40*3.10	G60
42.50*5.630	M	47.50*2.65	C	53.00*3.00	M	59.60*5.70	P60
42.52*2.62	A-131	47.50*3.55	C	53.00*3.55	C	59.69*5.33	A-332
43.00*2.00	M	47.50*5.30	C	53.00*5.00	M	59.92*3.53	A-229
43.00*2.50	M	47.60*5.70	P48A	53.00*5.30	C	59.99*2.62	A-142
43.00*3.00	M	47.70*3.50	P48	53.00*6.00	M	60.00*1.50	M
43.00*3.50	M	48.00*2.00	M	53.09*3.00	A-928	60.00*2.00	M
43.68*3.00	A-924	48.00*2.50	M	53.34*5.33	A-330	60.00*2.50	M
43.70*1.80	C	48.00*3.00	M	53.57*3.53	A-227	60.00*2.65	C
43.70*2.65	C	48.00*4.00	M	53.64*2.62	A-138	60.00*3.00	M
43.70*3.50	P44	48.00*5.00	M	53.70*1.78	A-034	60.00*3.50	M
43.70*3.55	C	48.00*6.00	M	54.00*2.50	M	60.00*3.55	C
43.70*5.30	C	48.70*1.80	C	54.00*3.00	M	60.00*4.00	M
43.82*5.33	A-327	48.70*2.65	C	54.00*4.00	M	60.25*4.50	M
44.00*2.00	M	48.70*3.50	P49	54.00*5.00	M	60.60*5.00	M
44.00*2.50	M	48.70*3.55	C	54.40*3.10	G55	60.00*5.30	C
44.00*3.00	M	48.70*5.30	C	54.50*2.65	C	60.00*7.00	M
44.00*4.00	M	48.90*2.62	A-135	54.50*3.55	C	60.05*1.78	A-036
44.00*5.00	M	49.00*2.50	M	54.50*5.30	C	61.50*2.65	C
44.04*3.53	A-224	49.00*3.00	M	54.60*5.70	P55	61.50*3.55	C
44.12*2.62	A-132	49.00*3.50	M	55.00*2.00	M	61.50*5.30	C
44.17*1.78	A-031	49.40*3.10	G50	55.00*2.50	M	61.60*2.62	A-143
44.40*3.10	G45	49.50*3.00	M	55.00*3.00	M	61.60*5.70	P62
44.70*3.50	P45	49.60*5.70	P50A	55.00*3.50	M	62.00*2.00	M
45.00*1.50	M	49.70*3.50	P50	55.00*4.00	M	62.00*2.50	M
45.00*1.80	C	50.00*1.80	C	55.00*5.00	M	62.00*3.00	M
45.00*2.00	M	50.00*2.00	M	55.00*6.00	M	62.00*4.00	M
45.00*2.50	M	50.00*2.50	M	55.25*2.62	A-139	62.00*5.00	M
45.00*2.65	C	50.00*2.65	C	55.60*5.70	P56	62.00*6.00	M
45.00*3.00	M	50.00*3.00	M	56.00*2.00	M	62.60*5.70	P63
45.00*3.50	M	50.00*3.55	C	56.00*2.65	C	62.87*5.33	A-333
45.00*3.55	C	50.00*4.00	M	56.00*3.00	M	63.00*2.00	M
45.00*4.00	M	50.00*4.50	M	56.00*3.55	C	63.000*2.50	M
45.00*4.50	M	50.00*5.00	M	56.00*4.00	M	63.00*2.65	C
45.00*5.00	M	50.00*5.30	C	56.00*5.30	C	63.00*3.00	M
45.00*5.30	C	50.00*6.00	M	56.52*5.33	A-331	63.00*3.55	C
45.00*5.50	M	50.16*6.99	A-405	56.74*3.53	A-228	63.00*5.30	C
45.69*2.62	A-133	50.17*5.33	A-329	56.82*2.62	A-140	63.09*3.53	A-230
45.70*3.50	P46	50.39*3.53	A-226	56.87*1.78	A-035	63.17*2.62	A-144
46.00*2.00	M	50.47*2.62	A-136	57.00*1.50	M	63.22*1.78	A-037
46.00*2.50	M	50.52*1.78	A-033	57.00*2.00	M	64.00*3.00	M
46.00*3.00	M	51.00*2.50	M	57.00*2.50	M	64.00*3.50	M
46.00*3.50	M	51.50*2.65	C	57.00*3.00	M	64.00*4.00	M
46.00*4.00	M	51.50*3.55	C	57.00*4.00	M	64.00*5.00	M
46.00*5.00	M	51.50*5.30	C	57.00*5.00	M	64.40*3.10	G65
46.20*1.80	C	51.60*5.70	P52	57.60*5.70	P58	64.60*5.70	P65
46.20*2.65	C	52.00*1.50	M	58.00*2.00	M	64.77*2.62	A-145
46.20*3.55	C	52.00*2.00	M	58.00*2.50	M	65.00*1.50	M
46.20*5.30	C	52.00*3.00	M	58.00*2.65	C	65.00*1.80	C
46.99*5.33	A-328	52.00*3.50	M	58.00*3.00	M	65.00*2.00	M
47.00*2.50	M	52.00*4.00	M	58.00*3.55	C	65.00*2.50	M
47.00*3.00	M	52.00*5.00	M	58.00*4.00	M	65.00*2.65	C
47.00*4.00	M	52.07*2.62	A-137	58.00*5.00	M	65.00*3.00	M
47.00*5.00	M	52.60*5.70	P53	58.00*5.30	C	65.00*3.50	M

尺寸 mm (内径*线径)	代 码	尺寸 mm (内径*线径)	代 码	尺寸 mm (内径*线径)	代 码	尺寸 mm (内径*线径)	代 码
65.00*3.55	C	72.69*2.62	A-150	82.00*3.00	M	93.00*3.00	M
65.00*4.00	M	72.75*1.78	A-040	82.00*4.00	M	93.00*6.50	M
65.00*4.50	M	73.00*2.50	M	82.00*5.00	M	94.00*2.50	M
65.00*5.00	M	73.00*2.65	C	82.14*3.53	A-236	94.00*3.00	M
65.00*5.30	C	73.00*3.00	M	82.22*2.62	A-152	94.00*4.00	M
66.00*2.00	M	73.00*3.55	C	82.27*1.78	A-042	94.40*3.10	G95
66.00*3.00	M	73.00*5.00	M	82.50*3.55	C	94.60*5.70	P95
66.04*5.33	A-334	73.00*5.30	C	82.50*5.30	C	94.62*5.33	A-343
66.27*3.53	A-231	74.00*2.00	M	83.00*3.50	M	94.84*3.53	A-240
66.34*2.62	A-146	74.00*3.00	M	84.00*2.00	M	94.92*2.62	A-154
66.40*1.78	A-038	74.00*4.00	M	84.00*3.50	M	94.97*1.78	A-044
66.60*5.70	P67	74.40*2.65	C	84.00*4.00	M	95.00*2.00	M
67.00*1.50	M	74.40*3.10	G75	84.40*3.10	G85	95.00*2.50	M
67.00*2.00	M	74.60*5.70	P75	84.60*5.70	P85	95.00*2.65	C
67.00*2.50	M	75.00*2.50	M	85.00*2.00	M	95.00*3.00	M
67.00*2.65	C	75.00*2.65	C	85.00*2.50	M	95.00*3.55	C
67.00*3.00	M	75.00*3.00	M	85.00*2.65	C	95.00*4.00	M
67.00*3.55	C	75.00*3.50	M	85.00*3.00	M	95.00*4.50	M
67.00*4.00	M	75.00*3.55	C	85.00*3.55	C	95.00*5.00	M
67.00*5.30	C	75.00*4.00	M	85.00*4.00	M	95.00*5.30	C
67.95*2.62	A-147	75.00*5.00	M	85.00*5.00	M	95.00*6.00	M
68.00*2.00	M	75.00*5.30	C	85.00*5.30	C	96.00*3.00	M
68.00*3.00	M	75.00*6.00	M	85.09*5.33	A-340	96.00*4.00	M
68.00*4.00	M	75.57*5.33	A-337	85.32*3.53	A-237	97.00*5.00	M
68.00*5.00	M	75.79*3.53	A-234	86.00*2.00	M	97.50*3.55	C
68.00*7.00	M	75.87*2.62	A-151	86.00*3.00	M	97.50*5.30	C
69.00*2.65	C	75.92*1.78	A-041	86.00*4.00	M	97.79*5.33	A-344
69.00*3.00	M	76.00*2.00	M	87.00*5.00	M	98.00*3.00	M
69.00*3.55	C	76.00*2.50	M	87.50*3.55	C	98.00*4.00	M
69.00*5.30	C	76.00*3.00	M	87.50*5.30	C	98.02*3.53	A-241
69.22*5.33	A-335	76.00*4.00	M	88.00*3.00	M	99.40*3.10	G100
69.40*3.10	G70	76.00*4.50	M	88.00*4.00	M	99.60*5.70	P100
69.44*3.53	A-232	77.50*3.55	C	88.00*5.00	M	100.00*1.00	M
69.52*2.62	A-148	77.50*5.30	C	88.00*6.00	M	100.00*1.50	M
69.57*1.78	A-039	78.00*2.00	M	88.27*5.33	A-341	1000.00*2.00	M
69.60*5.70	P70	78.00*3.00	M	88.49*3.53	A-238	100.00*2.65	C
70.00*2.00	M	78.00*4.00	M	88.57*2.62	A-153	100.00*3.00	M
70.00*2.50	M	78.00*5.00	M	88.62*1.78	A-043	100.00*3.55	C
70.00*3.00	M	78.74*5.33	A-338	89.00*4.50	M	100.00*4.00	M
70.00*4.00	M	78.97*3.53	A-235	89.40*3.10	G90	100.00*5.00	M
70.00*4.50	M	79.00*3.00	M	89.60*5.70	P90	100.00*5.30	C
70.00*5.00	M	79.00*7.00	M	90.00*2.00	M	100.00*6.00	M
70.00*8.00	M	79.40*3.10	G80	90.00*2.50	M	100.00*7.00	M
70.60*5.70	P71	79.50*3.00	M	90.00*2.65	C	100.00*8.00	M
71.00*2.65	C	79.60*5.70	P80	90.00*3.00	M	100.96*5.33	A-354
71.00*3.00	M	80.00*2.00	M	90.00*3.55	C	101.00*3.00	M
71.00*3.55	C	80.00*2.50	M	90.00*4.00	M	101.00*4.50	M
71.00*5.30	C	80.00*2.65	C	90.00*5.00	M	101.19*3.53	A-242
71.12*2.62	A-149	80.00*3.00	M	90.00*5.30	C	101.27*2.62	A-155
72.00*1.50	M	80.00*3.50	M	90.00*7.00	M	101.32*1.78	A-045
72.00*2.00	M	80.00*3.55	C	91.44*5.33	A-342	101.50*3.00	M
72.00*2.50	M	80.00*4.00	M	91.67*3.53	A-239	101.60*5.70	P102
72.00*3.00	M	80.00*5.00	M	92.00*3.00	M	102.00*3.00	M
72.00*4.00	M	80.00*5.30	C	92.00*4.00	M	102.00*4.00	M
72.00*5.00	M	80.00*6.00	M	92.00*5.00	M	103.00*3.55	C
72.39*5.33	A-336	80.00*8.00	M	92.50*3.55	C	103.00*5.30	C
72.62*3.53	A-233	81.92*5.33	A-339	92.50*5.30	C	103.00*6.00	M

尺寸 mm (内径*线径)	代 码	尺寸 mm (内径*线径)	代 码	尺寸 mm (内径*线径)	代 码	尺寸 mm (内径*线径)	代 码
104.00*3.00	M	112.00*5.30	C	120.37*1.78	A-048	130.00*4.50	M
104.00*4.00	M	112.00*7.00	C	121.00*5.00	M	130.00*5.00	M
104.00*5.00	M	112.00*8.00	M	122.00*3.00	M	130.00*6.00	M
104.00*6.00	M	113.67*5.33	A-349	122.00*3.55	C	130.00*8.00	M
104.14*5.33	A-346	113.67*6.99	A-425	122.00*4.00	M	131.60*5.70	P132
104.37*3.53	A-243	113.89*3.53	A-246	122.00*4.50	M	132.00*2.65	C
104.40*3.10	G105	113.97*2.62	A-157	122.00*5.00	M	132.00*3.00	M
104.50*3.00	M	114.00*3.00	M	122.00*5.30	C	132.00*3.55	C
104.60*5.70	P105	114.00*4.00	M	122.00*6.00	M	132.00*4.00	M
105.00*2.00	M	114.00*6.00	M	122.00*7.00	C	132.00*5.00	M
105.00*2.50	M	114.00*7.00	M	122.00*8.00	M	132.00*5.30	C
105.00*3.00	M	114.00*8.00	M	123.00*6.00	M	132.00*7.00	C
105.00*3.50	M	114.02*1.78	A-047	123.19*5.33	A-352	132.00*8.00	M
105.00*4.00	M	114.40*3.10	G115	123.19*6.99	A-428	132.72*5.33	A-355
105.00*5.00	M	114.60*5.70	P115	123.42*3.53	A249	132.72*6.99	A-431
105.00*6.00	M	115.00*2.00	M	124.00*3.00	M	132.94*3.53	A-252
106.00*2.00	M	115.00*2.50	M	124.00*4.00	M	133.00*3.50	M
106.00*2.65	C	115.00*3.00	M	124.40*3.10	G125	133.00*4.00	M
106.00*3.00	M	115.00*3.55	C	124.60*5.70	P125	133.02*2.62	A-160
106.00*3.55	C	115.00*4.00	M	125.00*2.00	M	133.07*1.78	A-050
106.00*5.00	M	115.00*4.50	M	125.00*2.50	M	134.00*3.00	M
106.00*5.30	C	115.00*5.00	M	125.00*2.65	C	134.00*4.00	M
106.00*7.00	M	115.00*5.30	C	125.00*3.00	M	134.00*4.00	M
107.00*2.50	M	115.00*5.30	C	125.00*3.00	M	134.40*3.10	G135
107.00*5.00	M	115.00*6.00	M	125.00*3.50	M	134.60*5.70	P135
107.32*5.33	A-347	115.00*7.00	C	125.00*3.55	C	135.00*2.50	M
107.54*3.53	A-224	116.00*3.00	M	125.00*4.00	M	135.00*3.00	M
107.62*2.62	A-156	116.00*4.00	M	125.00*5.00	M	135.00*3.50	M
107.67*1.78	A-046	116.84*5.33	A-350	125.00*5.30	C	135.00*4.00	M
108.00*3.00	M	116.84*6.99	A-426	125.00*6.00	M	135.00*5.00	M
108.00*4.00	M	117.00*4.00	M	125.00*7.00	C	135.00*6.00	M
108.00*5.00	M	117.00*7.00	M	126.00*4.00	M	135.89*5.33	A-356
108.00*6.00	M	117.07*3.53	A-247	126.00*4.50	M	135.89*6.99	A-432
108.00*8.00	M	118.00*2.00	M	126.37*5.33	A-353	136.00*3.50	M
109.00*3.55	C	118.00*2.65	C	126.37*6.99	A-429	136.00*3.55	C
109.00*5.30	C	118.00*3.00	M	126.59*3.53	A-250	136.00*4.00	M
109.00*7.00	C	118.00*3.55	C	126.67*2.62	A-159	136.00*5.00	M
109.40*3.10	G110	118.00*4.00	M	126.72*1.78	A-049	136.00*5.30	C
109.50*3.00	M	118.00*4.00	M	127.00*4.00	M	136.00*7.00	C
109.60*5.70	P110	118.00*4.50	M	128.00*2.00	M	136.12*3.53	A-253
110.00*2.00	M	118.00*5.00	M	128.00*2.50	M	137.00*4.00	M
110.00*3.00	M	118.00*5.30	C	128.00*2.50	M	138.00*3.00	M
110.00*3.50	M	118.00*6.00	M	128.00*3.00	M	138.00*5.00	M
110.00*4.00	M	118.00*7.00	C	128.00*3.55	C	138.00*6.00	M
110.00*4.50	M	119.00*3.00	M	128.00*4.00	M	139.00*7.00	M
110.00*5.00	M	119.40*3.10	G120	128.00*5.30	C	139.07*5.33	A-357
110.00*6.00	M	119.60*5.70	P120	128.00*6.00	M	139.07*6.99	A-433
110.00*7.00	M	120.00*2.00	M	128.00*7.00	C	139.29*3.53	A-254
110.00*8.00	M	120.00*2.50	M	128.00*9.00	M	139.37*2.62	A-161
110.49*5.33	A-346	120.00*3.00	M	129.00*4.00	M	139.40*3.10	G140
110.72*3.53	A-245	120.00*3.50	M	129.40*3.10	G130	139.50*3.00	M
111.60*5.70	P112	120.00*4.00	M	129.54*5.33	A-354	139.60*5.70	P140
112.00*2.65	C	120.00*4.00	M	129.54*6.99	A-430	140.00*2.00	M
112.00*3.00	M	120.00*4.50	M	129.60*5.70	P130	140.00*2.50	M
112.00*3.55	C	120.00*5.00	M	129.77*3.53	A-251	140.00*2.65	C
112.00*4.00	M	120.00*6.00	M	130.00*2.00	M	140.00*3.00	M
112.00*5.00	M	120.02*5.33	A-351	130.00*2.50	M	140.00*3.55	C
		120.02*6.99	A-427	130.00*3.00	M	140.00*4.00	M
		120.24*3.53	A-248	130.00*4.00	M		
		120.32*2.62	A-158				

尺寸 mm (内径*线径)	代 码	尺寸 mm (内径*线径)	代 码	尺寸 mm (内径*线径)	代 码	尺寸 mm (内径*线径)	代 码
140.00*5.00	M	153.00*3.00	M	170.00*3.50	M	185.00*4.50	M
140.00*5.30	C	153.00*6.00	M	170.00*3.55	C	185.00*5.00	M
140.00*6.00	M	154.00*3.00	M	170.00*4.00	M	185.00*5.30	C
140.00*7.00	C	154.30*5.70	G155	170.00*5.00	M	185.00*6.00	M
140.00*8.00	M	154.50*8.40	P155	170.00*5.30	C	185.00*7.00	C
142.00*3.00	M	155.00*3.00	M	170.00*6.00	M	186.00*3.50	M
142.00*4.00	M	155.00*3.55	C	170.00*7.00	C	186.00*7.00	M
142.00*6.00	M	155.00*4.00	M	170.00*8.00	M	188.00*2.00	M
142.24*5.33	A-358	155.00*5.00	M	170.82*5.33	A-364	188.00*3.00	M
142.24*6.99	A-434	155.00*5.30	C	170.82*6.99	A-440	188.00*4.00	M
142.47*3.53	A-255	155.00*7.00	C	171.04*3.53	A-261	188.00*6.00	M
143.00*2.00	M	156.00*2.00	M	171.12*2.62	A-166	189.30*5.70	G190
144.00*3.00	M	156.00*4.00	M	172.00*4.00	M	189.50*8.40	P190
144.00*4.00	M	158.00*5.00	M	172.00*6.00	M	189.87*5.33	A-367
144.00*5.00	M	158.00*6.00	M	172.00*7.00	M	189.87*6.99	A-443
144.40*3.10	G145	158.12*5.33	A-362	174.00*3.00	M	190.00*3.00	M
144.60*5.70	P145	158.12*6.99	A-438	174.30*5.70	G175	190.00*3.50	M
145.00*2.50	M	158.34*3.53	A-259	174.50*8.40	P175	190.00*3.55	C
145.00*3.50	M	158.42*2.62	A-164	175.00*3.55	C	190.00*4.00	M
145.00*3.55	C	159.00*4.00	M	175.00*4.00	M	190.00*5.00	M
145.00*4.00	M	159.30*5.70	G160	175.00*5.00	M	190.00*5.30	C
145.00*5.00	M	159.50*8.40	P160	175.00*5.30	C	190.00*6.00	M
145.00*5.30	C	160.00*2.00	M	175.00*6.00	M	190.00*7.00	C
145.00*7.00	C	160.00*2.50	M	175.00*7.00	C	190.00*8.00	M
145.00*8.00	M	160.00*2.65	C	177.00*3.50	M	190.10*3.53	A-264
145.42*5.33	A-359	160.00*3.00	M	177.00*4.00	M	190.17*2.62	A-169
145.42*6.99	A-435	160.00*3.55	C	177.17*5.33	A-365	192.00*2.00	M
145.64*3.53	A-256	160.00*4.00	M	177.17*6.99	A-441	192.00*3.00	M
145.72*2.62	A-162	160.00*4.50	M	177.39*3.53	A-262	192.00*4.00	M
146.00*3.00	M	160.00*5.00	M	177.47*2.62	A-167	193.00*6.00	M
146.00*4.00	M	160.00*5.30	C	179.00*3.00	M	194.00*2.00	M
148.00*6.00	M	160.00*6.00	M	179.30*5.70	G180	194.00*3.00	M
148.59*5.33	A-360	160.00*7.00	C	179.50*8.40	P180	194.30*5.70	G195
148.59*6.99	A-436	160.00*8.00	M	180.00*1.50	M	194.50*8.40	P195
148.82*3.53	A-257	164.00*3.00	M	180.00*2.65	C	195.00*2.50	M
149.00*3.00	M	164.00*4.00	M	180.00*3.00	M	195.00*3.00	M
149.30*5.70	G150	164.30*5.70	G165	180.00*3.50	M	195.00*3.50	M
149.50*8.40	P150A	164.46*5.33	A-363	180.00*3.55	C	195.00*3.55	C
149.60*5.70	P150	164.47*6.99	A-439	180.00*4.00	M	195.00*4.00	M
150.00*2.00	M	164.50*8.40	P165	180.00*5.00	M	195.00*5.00	M
150.00*2.50	M	164.69*3.53	A-260	180.00*5.30	C	195.00*5.30	C
150.00*2.65	C	164.77*2.62	A-165	180.00*6.00	M	195.00*6.00	W
150.00*3.00	M	165.00*2.00	M	180.00*7.00	C	195.00*7.00	C
150.00*3.55	C	165.00*3.50	M	180.00*8.00	M	196.22*5.33	A-368
150.00*4.00	M	165.00*3.55	C	182.00*3.00	M	196.22*6.99	A-444
150.00*4.50	M	165.00*4.00	M	182.00*6.00	M	196.44*3.53	A-265
150.00*5.00	M	165.00*5.00	M	183.52*5.33	A-366	196.52*2.62	A-170
150.00*5.30	C	165.00*5.30	C	183.52*6.99	A-442	198.00*4.00	M
150.00*6.00	M	165.00*7.00	C	183.74*3.53	A-263	199.30*5.70	G200
150.00*7.00	C	166.00*6.00	M	183.82*2.62	A-168	199.50*8.40	P200
150.00*8.00	M	167.00*3.00	M	184.00*3.00	M		
151.77*5.33	A-361	168.00*4.00	M	184.00*8.00	M		
151.77*6.99	A-437	169.30*5.70	G170	184.30*5.70	G185		
151.99*3.53	A-258	169.50*8.40	P170	184.50*8.40	P185		
152.00*5.00	M	170.00*2.50	M	185.00*3.00	M		
152.00*7.00	M	170.00*2.65	C	185.00*3.55	C		
152.07*2.62	A-162	170.00*3.00	M	185.00*4.00	M		

尺寸 mm (内径*线径)	代 码	尺寸 mm (内径*线径)	代 码	尺寸 mm (内径*线径)	代 码	尺寸 mm (内径*线径)	代 码
200.00*2.00	M	217.00*3.00	M	240.00*6.00	M	265.00*6.00	M
200.00*3.00	M	217.00*5.00	M	240.00*8.00	M	265.00*7.00	C
200.00*3.55	C	218.00*6.00	M	240.67*5.33	A-375	265.00*8.00	M
200.00*4.00	M	218.00*7.00	C	240.67*6.99	A-448	266.07*5.33	A-378
200.00*5.00	M	219.30*5.70	G220	240.89*3.53	A-272	266.07*6.99	A-450
200.00*5.30	C	219.50*8.40	P220	240.97*2.62	A-177	266.29*3.53	A-275
200.00*6.00	M	220.00*3.00	M	242.00*6.00	M	269.30*5.70	G270
200.00*7.00	C	220.00*4.00	M	243.00*7.00	C	269.50*8.40	P270
202.00*3.50	M	220.00*5.00	M	243.00*8.50	M	270.00*3.00	M
202.00*5.50	M	22.00*6.00	M	244.00*7.00	M	270.00*4.00	M
202.57*5.33	A-369	221.62*5.33	A-372	244.50*8.40	P245	270.00*5.00	M
202.57*6.99	A-445	221.84*3.53	A-269	245.00*3.00	M	270.00*6.00	M
202.79*3.53	A-266	221.92*2.62	A-174	245.00*5.00	M	272.00*7.00	C
202.87*2.62	A-171	222.00*4.00	M	246.00*4.00	M	274.00*3.00	M
203.00*3.00	M	224.00*5.30	C	247.00*7.00	M	274.50*8.40	P275
204.00*4.00	M	224.00*7.00	C	247.02*5.33	A-376	275.00*4.00	M
204.00*6.00	M	224.50*8.40	P225	247.24*3.53	A-273	275.00*5.00	M
204.50*8.40	P205	225.00*3.00	M	247.32*2.62	A-178	278.77*5.33	A-379
205.00*2.00	M	225.00*4.00	M	248.00*5.00	M	278.77*6.99	A-451
205.00*3.00	M	225.00*5.00	M	249.30*5.70	G250	278.99*3.53	A-276
205.00*5.00	M	226.00*8.00	M	249.50*8.40	P250	279.30*5.70	G280
205.00*6.00	M	227.97*5.33	A-373	25.00*3.00	M	279.50*8.40	P280
206.00*7.00	C	227.97*6.99	A-447	250.00*4.00	M	280.00*3.00	M
208.00*6.00	M	228.00*4.00	M	250.00*5.00	M	280.00*4.00	M
208.00*8.00	M	228.19*3.53	A-270	250.00*5.30	C	280.00*5.00	M
208.50*8.40	P209	228.27*2.62	A-175	25.00*6.00	M	280.00*5.30	C
208.92*5.33	A-370	229.30*5.70	G230	250.00*7.00	C	280.00*6.00	M
209.14*3.53	A-267	229.50*8.40	P230	250.00*7.00	M	28.00*7.00	C
209.22*2.62	A-172	230.00*3.00	M	250.00*8.00	M	280.00*8.00	M
209.30*5.70	G210	230.00*4.00	M	253.37*5.33	A-377	282.00*4.00	M
209.50*8.40	P210	230.00*5.00	M	253.37*6.99	A-449	284.00*6.00	M
210.00*3.00	M	230.00*6.00	M	253.59*3.53	A-274	284.50*8.40	P285
210.00*3.50	M	230.00*7.00	C	254.50*8.40	P255	285.00*3.00	M
210.00*4.00	M	230.00*8.00	M	255.50*4.00	M	285.00*4.00	M
210.00*5.00	M	233.00*3.00	M	255.00*5.00	M	289.30*5.70	G290
210.00*6.00	M	234.32*5.33	A-374	258.00*7.00	C	289.50*8.40	P290
210.00*8.00	M	234.50*8.40	P235	259.30*5.70	G260	290.00*3.00	M
212.00*4.00	M	234.54*3.53	A-271	259.50*8.40	P260	290.00*5.00	M
212.00*5.30	C	234.62*2.62	A-176	260.00*2.50	M	290.00*6.00	M
212.00*6.00	M	235.00*3.00	M	260.00*3.00	M	290.00*7.00	C
212.00*7.00	C	235.00*4.00	M	260.00*4.00	M	290.00*8.00	M
214.50*8.40	P215	235.00*5.00	M	260.00*5.00	M	291.47*5.33	A-380
215.00*3.00	M	235.00*7.00	M	260.00*6.00	M	291.47*6.99	A-452
215.00*5.00	M	236.00*5.30	C	260.00*7.00	M	291.69*3.53	A-277
215.00*6.00	M	236.00*7.00	C	260.00*8.00	M	292.00*4.00	M
215.00*7.00	M	238.00*5.00	M	262.00*6.00	M	294.50*8.40	P295
215.27*5.33	A-371	239.30*5.70	G240	264.50*8.40	P265	295.00*6.00	M
215.27*6.99	A-446	239.50*8.40	P240	265.00*3.00	M	297.00*4.00	M
215.49*3.53	A-268	240.00*3.00	M	265.00*4.00	M	299.30*5.70	G300
215.57*2.62	A-173	240.00*4.00	M	265.00*5.00	M	299.50*8.40	P300
216.00*4.00	M	240.00*5.00	M	265.00*5.30	C		

尺寸 mm (内径*线径)	代 码	尺寸 mm (内径*线径)	代 码	尺寸 mm (内径*线径)	代 码	尺寸 mm (内径*线径)	代 码
300.00*3.00	M	345.00*5.00	M	400.00*4.00	M	500.00*7.00	C
300.00*5.00	M	345.00*7.00	C	400.00*5.00	M	506.86*5.33	A-389
300.00*5.30	C	347.00*9.00	M	400.00*5.30	C	506.86*6.99	A-469
300.00*6.00	M	350.00*5.00	M	400.00*7.00	C	515.00*7.00	C
300.00*7.00	C	354.50*8.40	P355	400.00*8.00	M	530.00*7.00	C
304.17*5.33	A-381	354.97*5.33	A-383	405.26*3.53	A-282	532.26*5.33	A-390
304.17*6.99	A-453	354.97*6.99	A-457	405.26*5.33	A-385	532.26*6.99	A-470
304.39*3.53	A-278	355.00*4.00	M	405.26*6.99	A-461	545.00*7.00	C
305.00*4.00	M	355.00*5.00	M	410.00*4.00	M	557.66*5.33	A-391
305.00*5.00	M	355.00*5.30	C	410.00*8.00	M	557.66*6.99	A-471
307.00*7.00	C	355.00*6.00	M	412.00*7.00	C	560.00*7.00	C
310.00*3.00	M	355.00*7.00	C	412.00*8.00	M	580.00*7.00	C
310.00*4.00	M	355.19*3.53	A-280	415.00*5.00	M	582.68*5.33	A-392
310.00*5.00	M	359.50*8.40	P360	417.96*6.99	A-462	582.68*6.99	A-472
314.00*8.00	M	360.00*4.00	M	420.00*4.00	M	600.00*7.00	C
314.50*8.40	P315	360.00*8.00	M	420.00*5.00	M	608.08*5.33	A-393
315.00*4.00	M	365.00*7.00	C	425.00*4.00	M	608.08*6.99	A-473
315.00*5.00	M	367.00*3.50	M	425.00*7.00	C	615.00*7.00	C
315.00*5.30	C	367.00*5.00	M	425.00*8.00	M	630.00*7.00	C
315.00*6.00	M	367.67*6.99	A-458	429.00*6.00	M	633.48*5.33	A-394
315.00*7.00	C	368.00*6.00	M	430.66*3.53	A-283	633.48*6.99	A-474
316.87*6.99	A-454	370.00*4.00	M	430.66*5.33	A-386	650.00*7.00	C
319.50*8.40	P320	370.00*5.00	M	430.66*6.99	A-463	658.88*5.33	A-395
320.00*2.50	M	371.00*8.50	M	437.00*7.00	C	658.88*6.99	A-475
320.00*3.00	M	374.00*8.00	M	440.00*4.00	M	670.00*7.00	C
320.00*5.00	M	374.50*8.40	P375	443.36*6.99	A-464		
320.00*6.00	M	375.00*5.00	M	444.00*8.00	M		
320.00*7.00	M	375.00*5.33	C	448.00*6.00	M		
320.00*8.00	M	375.00*7.00	C	450.00*5.00	M		
325.00*5.00	M	376.00*6.00	M	450.00*7.00	C		
325.00*6.00	M	380.00*3.00	M	456.06*3.53	A-284		
325.00*7.00	C	380.00*4.00	M	456.06*5.33	A-387		
329.57*5.33	A-382	380.00*8.00	M	456.06*6.99	A-465		
329.57*6.99	A-455	380.37*5.33	A-384	460.00*4.00	M		
329.79*3.53	A-279	380.37*6.99	A-459	460.00*5.00	M		
330.00*4.00	M	380.59*3.53	A-281	460.00*8.00	M		
330.00*5.00	M	384.50*8.40	P385	462.00*7.00	C		
330.00*6.00	M	385.00*5.00	M	468.76*6.99	A-466		
330.00*8.00	M	386.00*6.00	M	470.00*4.00	M		
331.00*3.00	M	387.00*7.00	C	470.00*6.00	M		
334.50*8.40	P335	390.00*4.00	M	475.00*5.00	M		
335.00*5.30	C	390.00*9.00	M	475.00*7.00	C		
335.00*6.00	M	393.07*6.99	A-460	480.00*6.00	M		
335.00*7.00	C	395.00*5.00	M	481.46*5.33	A-388		
339.50*8.40	P340	399.50*8.40	P400	481.46*6.99	A-467		
340.00*3.50	M			487.00*7.00	C		
340.00*4.00	M			490.00*5.00	M		
340.00*5.00	M			490.00*8.00	M		
340.00*6.00	M			492.00*4.00	M		
342.00*8.00	M			494.16*6.99	A-468		
342.27*6.99	A-456						

* 其他未列尺寸, 请咨询我司

* 本公司可生产内径2米以上无接缝、一体硫化O型圈

公差表

内径(ID)	公差(±)	内径(ID)	公差(±)	线径(ID)	公差(±)
0-1.79	0.10	185.00-257.99	1.20	0-1.79	0.07
1.80-6.29	0.13	258.00-324.99	1.60	1.80-2.64	0.08
6.30-10.59	0.14	325.00-411.99	2.10	2.65-3.54	0.09
10.60-18.99	0.17	412.00-514.99	2.60	3.55-5.29	0.10
19.00-31.49	0.22	515.00-649.99	3.20	5.30-6.99	0.13
31.50-41.19	0.30	650.00-670.00	4.00	7.00-8.00	0.15
41.20-51.49	0.36	670.01-999.00	5.00	8.01-10.00	0.20
51.50-64.99	0.44	999.01-1200.00	6.00	10.01-15.00	0.25
65.00-82.49	0.53	1200.01-1500.00	7.00	15.01-25.00	0.35
82.50-121.99	0.65	1500.01-1800.00	8.00	25.01-100.00	0.45
122.00-184.99	0.90	1800.01-2000.00	9.00		

管接头密封圈(ED圈)

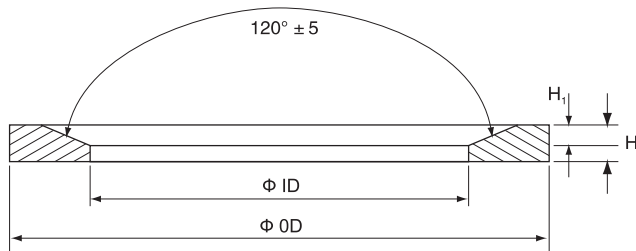

胶垫代码	名义编号	螺纹	英制	ID	OD	H ^{+0.1}	H ₁
WD-M08	8	M8*1	-	6.50	9.9	1.00	0.50
WD-B02	10	G1/8"*28	1/8	8.40	11.90	1.00	0.50
WD-M12	12	M12*1.5	-	9.80	14.40	1.50	0.80
WD-B04	14	G1/4"*19	1/4	11.60	16.50	1.50	0.80
WD-M16	16	M16*1.5	-	13.80	18.90	1.50	0.80
WD-B06	17	G3/8"*19	3/8	14.70	18.90	1.50	0.80
WD-M18	18	M18*1.5	-	15.70	20.90	1.50	0.80
WD-M20	20	M20*1.5	-	17.80	22.90	1.50	0.80
WD-B08	21	G1/2"*14	1/2	18.50	23.90	1.50	0.80
WD-M22	22	M22*1.5	-	19.60	24.30	1.50	0.80
WD-M24	24	M24*1.5	5/8	21.80	26.90	1.50	0.80
WD-B12	26	G3/4"*14	3/4	23.90	29.20	1.50	0.80
WD-B12	27	M27*2	3/4	23.90	29.20	1.50	0.80
WD-B16	33	G1"*11	1	29.70	35.70	2.00	1.00
WD-B20	42	G1-1/4"*11	1-1/4	38.80	45.80	2.00	1.00
WD-M24	48	G1-1/2"*11	1-1/2	44.70	50.70	2.00	1.00
WD-B32	60	M60*2	2	56.50	66.50	4.00	2.00

英制自定心型 Nomina 1 Diameter	尺寸 Dimensions				适用螺纹 英制 Inch
	ID ₁	ID	OD	H	
BS/A 6.8		6.86	13.20	1.50	
BS/A 8.6		8.64	14.22	1.50	
BS/A 10.3	8.26	10.37	15.88	1.85	1/8"
BS/A 10.4		10.37	18.50	2.00	
BS/A 13.7	11.18	13.74	20.57	1.85	1/4"
BS/A 14.8		14.86	22.23	1.85	
BS/A 16.5		16.51	25.40	1.85	
BS/A 17.2	14.76	17.28	23.80	1.85	3/8"
BS/A 19.6		19.69	26.92	2.35	
BS/A 21.5	18.24	21.54	28.58	2.35	1/2"
BS/A 23.5		23.49	31.75	2.35	5/8"
BS/A 24.2		24.26	33.27	2.35	
BS/A 27.1	23.83	27.05	34.93	2.35	3/4"
BS/A 30.8	27.51	30.81	38.10	2.35	7/8"
BS/A 33.8	29.92	33.89	42.80	2.35	1"
BS/A 33.8A	29.92	33.89	42.80	3.40	1"
BS/A 35.9A		35.94	44.45	3.40	
BS/A 42.9	38.45	42.93	52.38	2.35	1-1/4"
BS/A 42.9A	38.45	42.93	52.38	3.40	1-1/4"
BS/A 48.5	44.45	48.44	58.60	2.35	1-1/2"
BS/A 48.5A	44.45	48.44	58.60	3.40	1-1/2"
BS/A 54.8A	50.42	54.89	69.85	3.40	1-3/4"
BS/A 60.5	56.26	60.58	73.03	2.35	2"
BS/A 60.5A	56.26	60.58	73.03	3.40	2"

自定芯组合垫圈

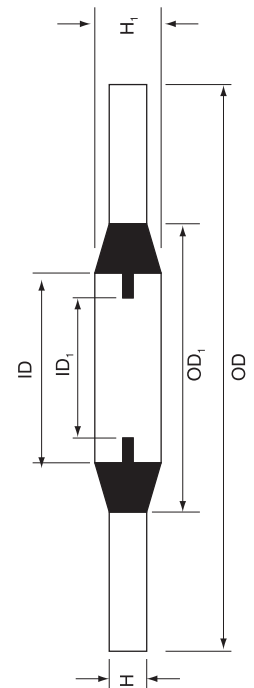

国标准型 JB982-77标准	尺寸 Dimensions			适用螺纹公制
	ID	OD	H	
M8	8.4	14	2.00	M8
M10	10.4	16	2.00	M10
M12	12.4	18	2.00	M12
M14	14.4	20	2.00	M14
M16	16.4	22	2.00	M16
M18	18.4	25	2.00	M18
M20	20.5	28	2.00	M20
M22	22.5	30	2.00	M22
M24	24.5	32	2.00	M24
M27	27.5	35	2.00	M27
M30	30.5	38	2.00	M30
M33	33.5	42	2.00	M33
M36	36.6	46	2.00	M36
M39	39.6	50	2.00	M39
M42	42.6	53	2.00	M42
M45	45.6	56	2.00	M45
M48	48.7	60	2.00	M48
M52	52.7	66	2.00	M52
M60	60.7	75	2.00	M60

组合垫圈(一般)

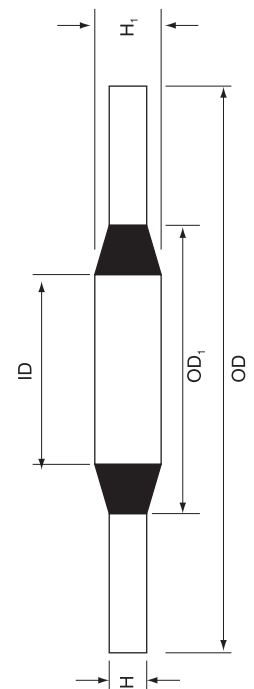

储存指导

密封件通常作为备件，要存放较长时间。在受到诸如：扭曲、氧气、臭气、光照、热源、潮湿、油品或溶剂等的影响下，O型圈可能会因其物理化学性质的改变而失效。在D17716、ISO2230、DIN9088等标准中对橡胶密封件的尺寸、清洁、维护做了基本的规定。

根据材料的类别，这些标准给出了存放条件的规定以及存放周期的推荐值。为保持弹性体的理化性能，请遵循以下储存规则，这些原则的目的是为了保持一个最合适的储存条件：

- 温度

5℃到25℃是理想的储存温度。应避免接触热源及阳光照射。对从低温储藏状态取出的密封件，应先将其置于20℃环境中一段时间后再使用。

- 湿度

仓库的相对湿度应低于70%，要避免过于潮湿或者过于干燥，不可出现冷凝现象。

- 光照

要避免阳光极强的含紫外线的人工光源。防紫外线的包装袋可提供最佳的保护。建议仓库的窗户上红色或橙色涂料或贴防晒膜。

- 辐射

要避免电离辐射对密封件的损伤。

- 氧和臭氧

橡胶材料应避免暴露在循环流动的空气中。可通过包装、缠绕，存放在气密容器中或其他合适的方法来实现该目的。臭氧对许多弹性体有害，储藏室中要避免以下设备：水银蒸气灯、高压电气设备、电动机、会产生火花或静电的设备。

- 变形

弹性体材料应尽可能以自由状态放置，避免受拉伸，受压或其他变形。若原包装弹性体是处于无变形的状态，则应尽量使用原包装。与液体或半固体材料的接触：橡胶密封件不得接触溶剂、油脂，或其他半固体材料(除非厂家原包装如此)与金属和非金属材料接触：不容许接触磁性材料、铸铁、铜及其合金、或含有会损害橡胶的那些材料。不可使用PVC材料来包装密封件。不同材料的密封件不得混装在一起。

- 清洁

根据需要可以用肥皂、水来清洗密封件。但是水不准接触纤维增强密封件、橡胶金属粘接密封件、AU制作。消毒剂、有机溶剂及锐变的工具都不准使用。清洗后的密封件应在室温下晾干，不可接近热源。

- 保存期限和监控

弹性体的保存期限是由橡胶材料类别来决定的。再推荐的储存条件下，这些材料的保存期限如下：

- 聚氨脂、热塑性材料=4年
- 丁青橡胶、氢化丁青橡胶、氯丁橡胶=6年
- 乙丙橡胶=8年
- 氟橡胶，硅橡胶，氟硅橡胶=10年
- 聚四氟乙烯=无期限

超过上述期限后，应在使用前予以检查。经检查后，或者有可能还能使用一段时间。

即使在上述良好的状况下保存，厚度小1.5 mm的橡胶很容易氧化而失效。因此，对这类产品，即使在上述年限内，也必须经常地检查并测试。

赫鲁格工程技术人员使用高效的CAD/CAE/CAM, Pro/E等2D、3D设计软件, 可根据客户的构思、图纸或者样品, 对复杂的非标产品进行设计, 快速出样, 及批量精密加工。



航空连接件



电力电器配件



医疗设备配件

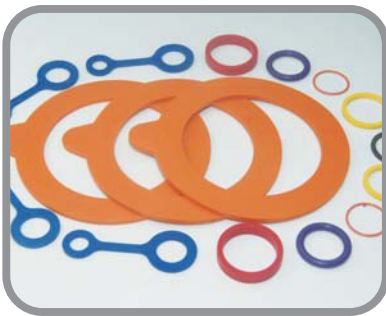

小家电配件



汽车线束配件



电子配件

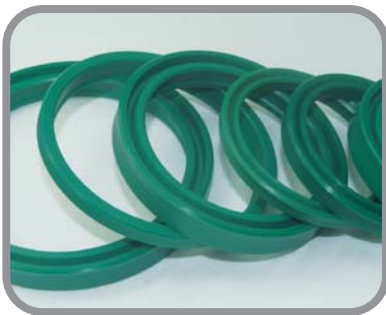

液压气动密封件



医疗设备垫片



油箱密封塞



半导体设备配件



家用电器配件



其他产品

www.herrug.cn/www.herrug.net.cn

质量为生命 诚信为根本 

上海赫鲁格精密橡胶有限公司

Shanghai Herrug Precision Rubber.Co.,Ltd

地址: 上海市松江区九亭久富开发区叶亭路1号3号厂房二楼

电话: 021-6763 6270 / 3352 6321 传真: 021-3352 6065

邮件: sales@herrug.cn / sales@herrug.net.cn

网址: www.herrug.cn / www.herrug.net.cn