

# DATA SHEET

TYPE: 60A/300V

Package: T0-3P

Prepared by	Audit by	Approved by

## Product specifications

### Product Application:

- Switch mode Power Supply
- Inverters
- Free Wheeling Diode
- Motor Controllers
- Converters
- Inverters
- Snubber Diode
- PFC

**VRRM = 300V**

**IFAV = 60A(30Ax2)**

**VF = 1.1V**

**TRR = 35ns**

### Product Features:

- Ultrafast Recovery Times
- Soft Recovery Characteristics
- Popular T0-247 Package
- Low Forward Voltage
- Low Leakage Current
- Avalanche Energy Rated

### Product Benefits:

- Low Losses
- Low Noise Switching
- Cooler Operation
- Higher Reliability Systems
- Increased System Power Density

### Package:

**S2FD60B30 G**

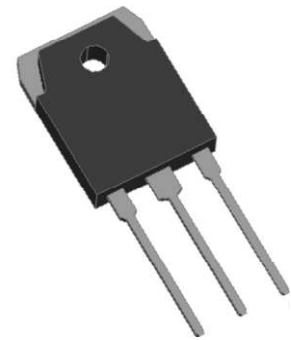

**1 2 3**

### Circuit diagram

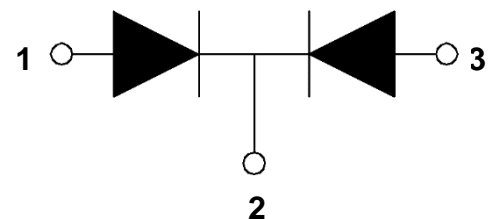

**1 - Anode**

**3 - Anode**

**2 - Cathode**

**MAXIMUM RATINGS**

All Ratings: Tc = 25° C unless otherwise specified.

Symbol	Characteristic / Test Conditions	TYP	UNIT
VR	Maximum D.C. Reverse Voltage	300	Volts
VRRM	Maximum Peak Repetitive Reverse Voltage		
IF(AV)	Maximum Average Forward Current (Tc = 120°C, Duty Cycle = 0.5)	60(30*2)	Amps
IFSM	Non-Repetitive Forward Surge Current (Tj = 25°C, 8.3ms)	750	
TJ , TSTG	Operating and Storage Temperature Range	-55 to 150	° C
TL	Lead Temperature for 10 Sec	260	

**STATIC ELECTRICAL CHARACTERISTICS**

Symbol	Characteristic / Test Conditions	TYP	MAX	UNIT	
VF	Forward Voltage	IF = 30A, Tj = 25°C	1.1	1.2	Volts
		IF = 30A, Tj = 150°C	0.9		
IRM	Maximum Reverse Leakage Current	VR = 300V, Tj =25°C		5	μ A
		VR = 300V, Tj =150°C		100	
Trr	Reverse Recovery Time	IF=0.5A    IRM=1A IRR=0.25A    TC=25°C	35	45	ns

**THERMAL AND MECHANICAL CHARACTERISTICS**

Symbol	Characteristic / Test Conditions	S2FD60A30 G	UNIT
Rθ JC	Thermal Resistance Junction-to-Case (Per Package)	0.88	°C/W
Wt	Package Weight	6.7	g
Torque	Maximum Mounting Torque	1.1	N.m

TYPICAL PERFORMANCE CURVES

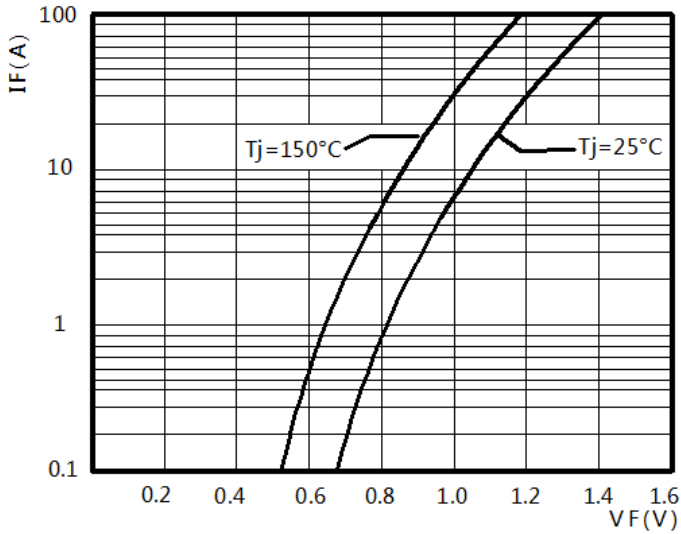

FIGURE 1. FORWARD CURRENT vs FORWARD VOLTAGE

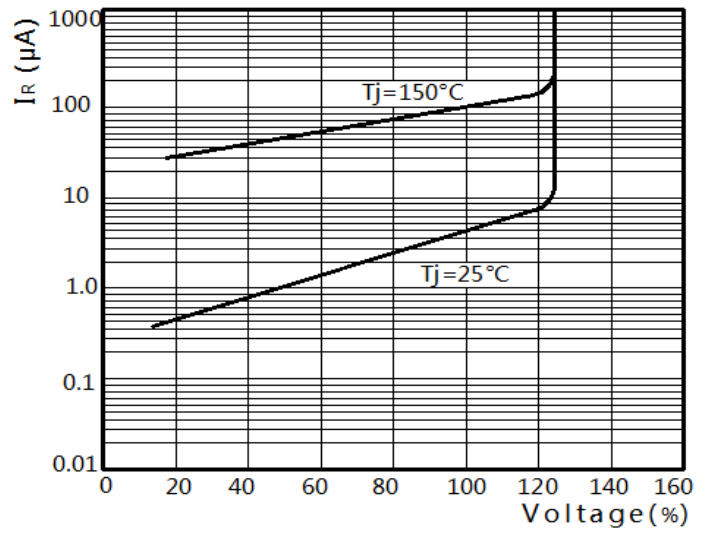

FIGURE 2. REVERSE CURRENT vs REVERSE VOLTAGE

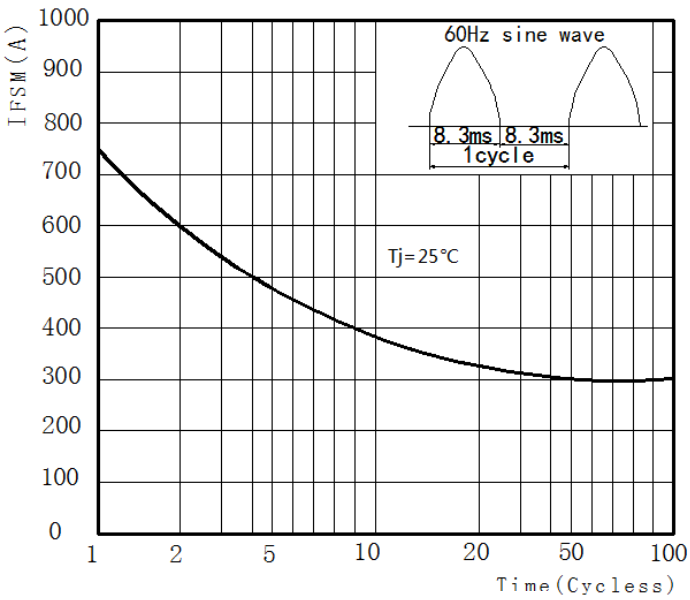

FIGURE 3. Peak Surge Forward Capability

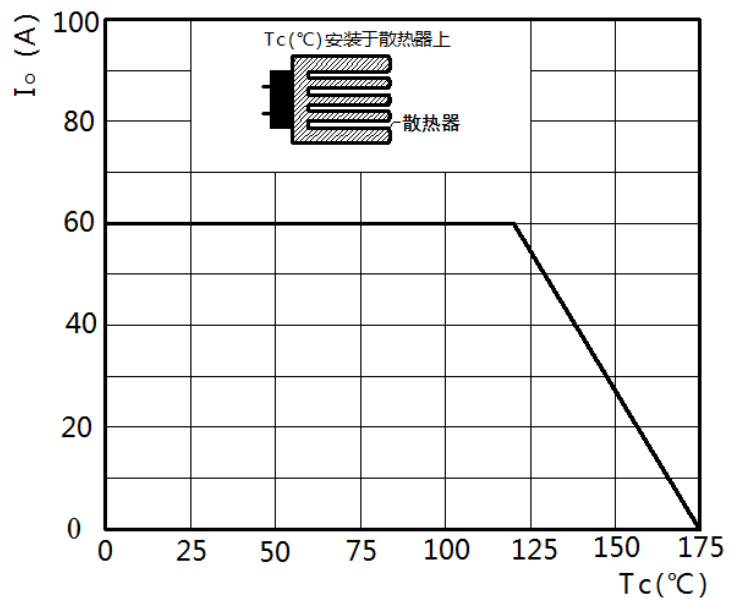

FIGURE 4. CURRENT DERATING CURVE

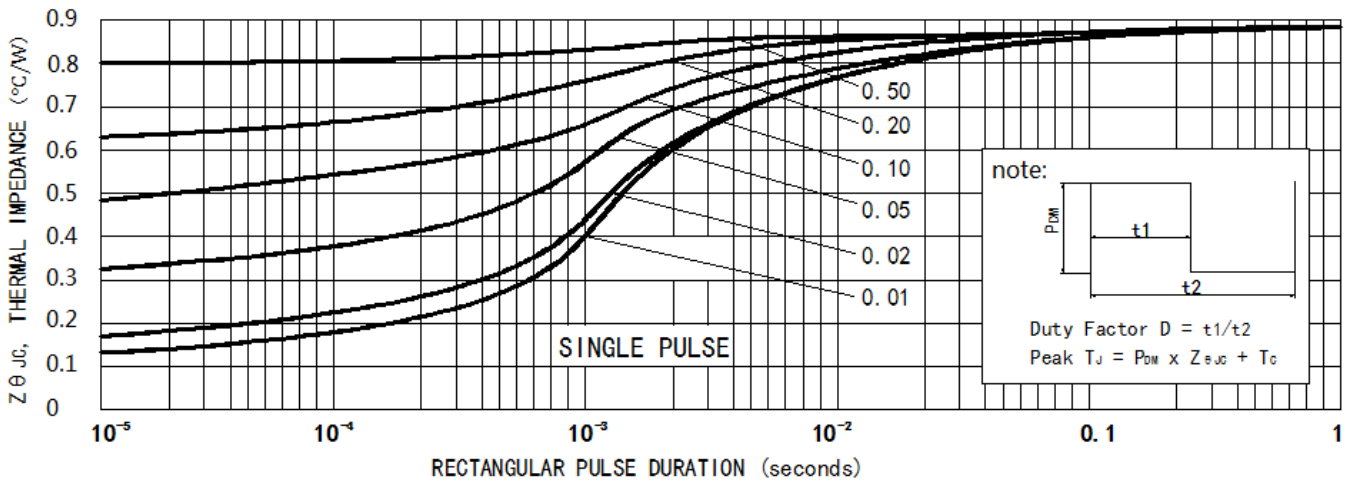
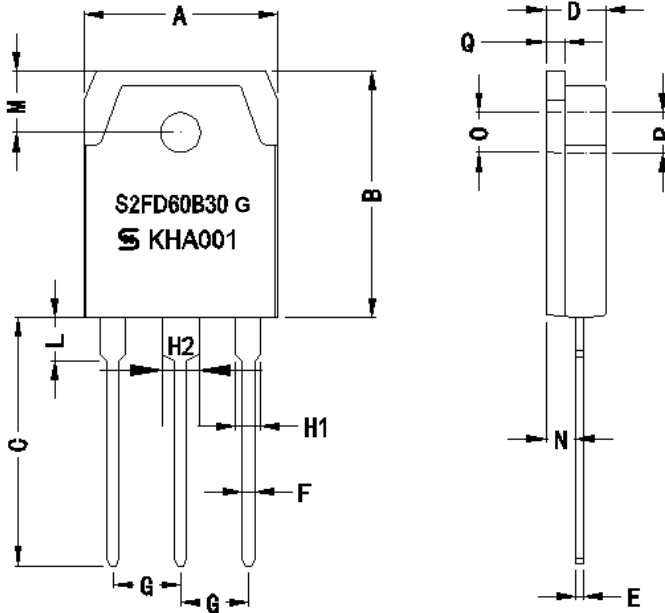

FIGURE 5. Rectangular Pulse Duration vs Thermal Impedance

■尺寸图 Dimension Drawing



Dim.	Unit(mm)		Unit(inch)	
	min	max	min	max
A	15.1	16.1	0.594	0.634
B	19.4	20.4	0.764	0.803
C	19	20	0.748	0.787
D	4.3	5.3	0.169	0.209
E	0.4	0.8	0.016	0.031
F	0.8	1.2	0.031	0.047
G	5.25	5.65	0.207	0.222
H1	1.8	2.2	0.071	0.087
H2	2.8	3.2	0.110	0.126
L	2.7	3.1	0.106	0.122
M	4.7	5.3	0.185	0.209
N	2.2	2.6	0.087	0.102
O	3	3.3	0.118	0.130
P	3.3	3.6	0.130	0.142

Marking

