

60A/400V 快恢复二极管 60A/400V Fast Recovery Diodes

■特征 Features

- 超快恢复时间
Ultrafast Recovery Times
- 软恢复特性
Softer Recovery Characteristics
- 低正向电压
Low Forward Voltage
- 低反向漏电流
Low reverse leakage current

■应用范围 Applications

- 续流二极管
Free Wheeling Diode
- 电机控制器
Motor Controllers
- 开关式电源
Switching mode power supply
- 转换器
Converters
- 逆变器
Inverters
- 缓冲二极管
Snubber Diode
- 功率因数校正
PFC:Power Factor Correction

关键参数 KEY PARAMETERS		
参数 PARAMETER	数值 VALUE	单位 UNIT
$I_{F(AV)}$	60	A
V_F	0.95	V
V_{RRM}	400	V
TRR	38	ns
Package	TO-247	

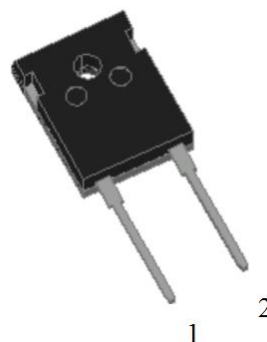

1 - 负极 Cathode
2 - 正极 Anode

■机械参数 Mechanical Data

- 安装扭矩: 8.0kgf.cm
Mounting torque: 8.0kgf.cm max
- 重量: 约 6.4 克
Weight : About 6.4grams

■最大额定值 Maximum Ratings @ Ta = 25°C unless otherwise noted

特征/测试条件 Characteristic / Test Conditions	符号 SYMBOL	典型值 TYP	单位 UNIT
反向重复峰值电压 Maximum recurrent peak reverse voltage	VRRM	400	V
最大平均正向电流 Maximum Average Forward Current	$I_{F(AV)}$	60	A
最大正向浪涌电流, 8.3ms 单半正弦波叠加在额定负载上 Peak surge forward current, 8.3ms single half sine-wave superimposed on rated load	IFSM	400	A
结温、存储温度 Operating and Storage Temperature Range	TJ、TSTG	-55 ~ +150	°C
耐焊接热, 高温持续 10 秒 Resistance to Soldering Heat, Lead Temperature for 10 Sec	TL	260	°C

■ 电性特性 Electrical Characteristics @ Ta = 25°C unless otherwise noted

特征/测试条件 Characteristic / Test Conditions	符号 SYMBOL	典型值 TYP	最大值 MAX	单位 UNIT
正向峰值电压 Peak Forward Voltage	VF	IF=60Aj=25°C	1.15	1.4
		IF=60Aj=125°C	0.95	1.2
VR=VRRM, 脉冲测试, 单个二极管的额定值 VR=VRRM, Pulse measurement Rating of per diode	IR	Tj=25°C	/	5
		Tj=125°C	/	500
反向恢复时间 Reverse Recovery Time	TRR	IF=0.5A IRR=0.25A IRM=1A TC=25°C	38	45
				ns

■ 热特性 Thermal Characteristics @ Ta = 25°C unless otherwise noted

特征/测试条件 Characteristic / Test Conditions	符号 SYMBOL	S1F60A40 H	单位 UNIT
结到管壳的热阻,有散热片 Junction to case Thermal Resistance, with heat sink	RθJC	0.7	°C/W

■ 特性曲线 Characteristic Curve

FIG.1 . Derating Curve For Output Rectified Current

图 1. 电流降额曲线

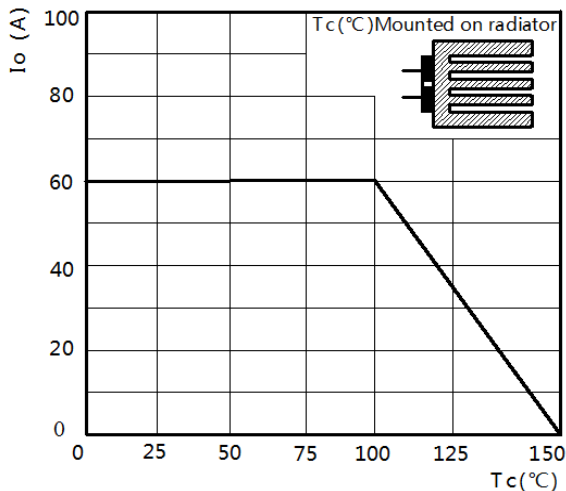

FIG3. Typical Reverse Characteristics Per Bridge Element

图 3. 典型反向特性

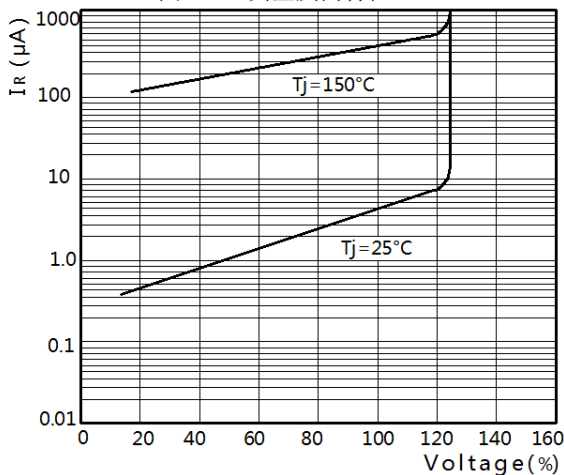

FIG.2 . Maximum Non-Repetitive Peak Forward Surge Current Per Bridge Element

图 2. 最大正向不重复峰值浪涌电流

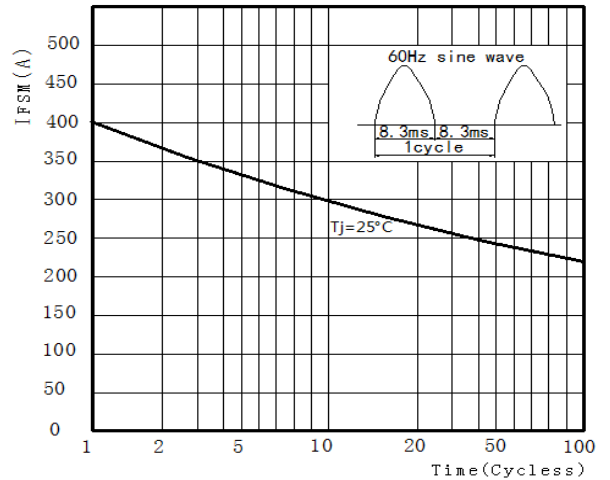
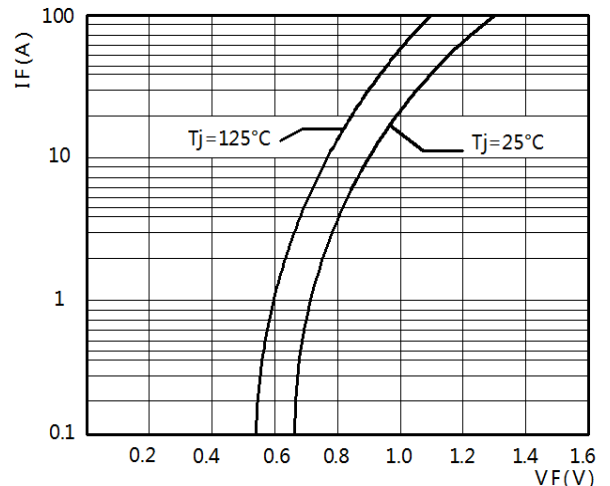
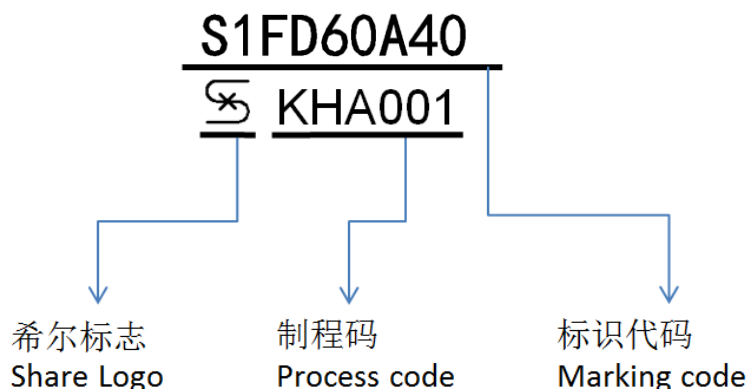

FIG4. Typical Forward Characteristics Per Bridge Element

图 4. 典型正向特性



■ 标记图 Marking Diagram



■ 尺寸图 Dimension Drawing

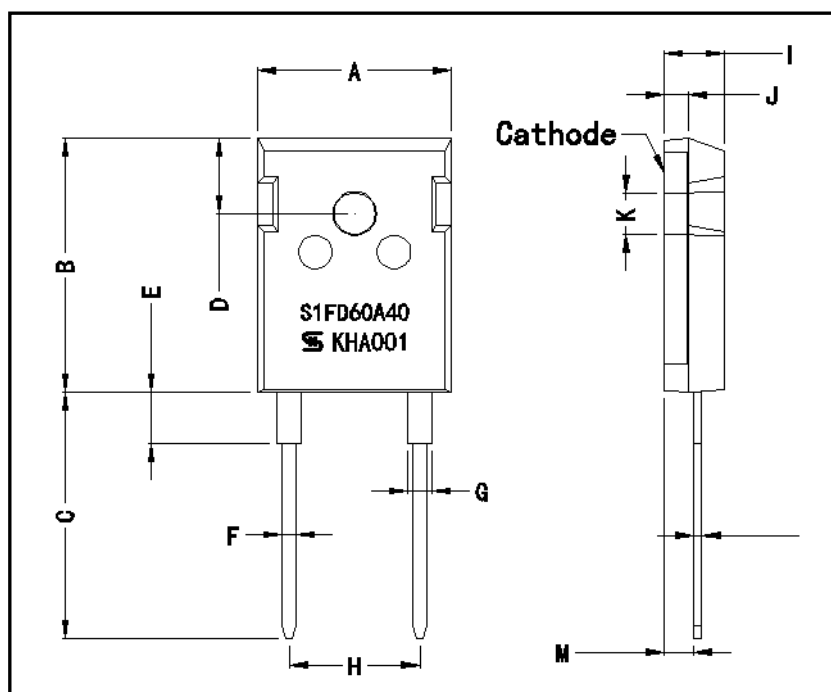

Dim.	Unit(mm)		Unit(inch)	
	min	max	min	max
A	15.70	16.30	0.62	0.64
B	20.70	21.30	0.81	0.84
C	19.50	20.50	0.77	0.81
D	5.70	6.70	0.22	0.26
E	4.00	4.40	0.16	0.17
F	1.00	1.40	0.04	0.06
G	1.70	2.30	0.07	0.09
H	10.5	11.1	0.20	0.23
I	4.70	5.30	0.19	0.21
J	1.70	2.30	0.07	0.09
K	3.20	3.80	0.13	0.15
L	0.50	0.70	0.02	0.03
M	2.20	2.60	0.09	0.10

Notice

The information presented in this document is for reference only. Leshan Share Electronic Co., Ltd. reserves the right to make changes without notice for the specification of the products displayed herein to improve reliability, function or design or otherwise.

本文档提供的信息仅供参考。为提高产品的可靠性、功能或设计等，乐山希尔电子股份有限公司保留对此产品规格进行更改的权利，恕不另行通知。