

30A/600V 快恢复二极管 30A/600V Fast Recovery Diodes

■特征 Features

- 超快恢复时间
Ultrafast Recovery Times
- 软恢复特性
Softer Recovery Characteristics
- 低正向电压
Low Forward Voltage
- 低反向漏电流
Low reverse leakage current

■应用范围 Applications

- 续流二极管
Free Wheeling Diode
- 电机控制器
Motor Controllers
- 开关式电源
Switching mode power supply
- 转换器
Converters
- 逆变器
Inverters
- 缓冲二极管
Snubber Diode
- 功率因数校正
PFC: Power Factor Correction

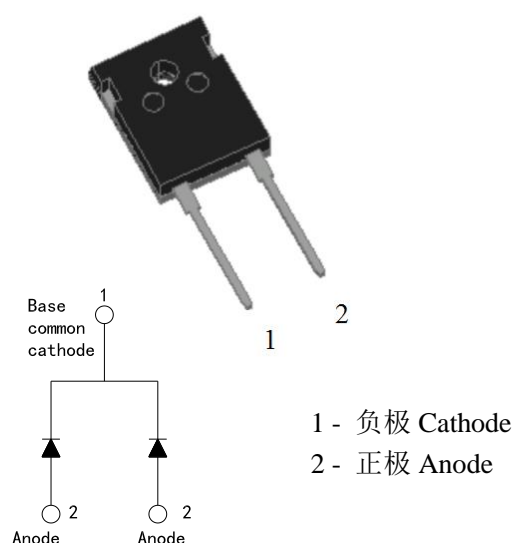
■机械参数 Mechanical Data

- 安装扭矩: 8.0kgf.cm
Mounting torque: 8.0kgf.cm max
- 重量: 约 6.4 克
Weight : About 6.4 grams

■最大额定值 Maximum Ratings @ Ta = 25°C unless otherwise noted

特征/测试条件 Characteristic / Test Conditions	符号 SYMBOL	额定值 Rated value	单位 UNIT
反向重复峰值电压 Maximum recurrent peak reverse voltage	VRRM	600	V
最大平均正向电流, TC=100°C Maximum Average Forward Current, TC=100°C	IF(AV)	30	A
最大正向浪涌电流, 10ms 正弦半波 Peak surge forward current, 10ms single half sine-wave superimposed on rated load	IFSM	400	A
功率损耗 Power Dissipation	PD	187	W
结温 Junction Temperature	TJ	-55 ~ +175	°C
存储温度 Storage Temperature Range	TSTG	-55 ~ +150	°C
耐焊接热, 高温持续 10 秒 Resistance to Soldering Heat, Lead Temperature for 10 Sec	TL	260	°C

关键参数 KEY PARAMETERS		
参数 PARAMETER	数值 VALUE	单位 UNIT
IF(AV)	30	A
VF	1.4	V
VRRM	600	V
TRR	35	ns
Package	TO-247	



■ 电性特性 Electrical Characteristics @ Ta = 25°C unless otherwise noted

特征/测试条件 Characteristic / Test Conditions	符号 SYMBOL	典型值 TYP	最大值 MAX	单位 UNIT	
正向峰值电压 Peak Forward Voltage	VF	IF=30A, Tj=25°C	1.4	1.6	V
		IF=30A, Tj=150°C	1.0	/	V
VR=VRRM, 脉冲测试, 单个二极管的额定值 VR=VRRM, Pulse measurement Rating of per diode	IR	Tj=25°C	/	5	μA
		Tj=150°C	/	500	
反向恢复时间 Reverse Recovery Time	TRR	IF=0.5A IRRM=1A IRR=0.25A TC=25°C	35	45	ns

■ 电性特性 Electrical Characteristics @ Ta = 25°C unless otherwise noted

符号 SYMBOL	特征/测试条件 Characteristic / Test Conditions	典型值 TYP	最大值 MAX	单位 UNIT
TRR	反向恢复时间 Reverse Recovery Time	50	/	ns
IRRM	最大反向恢复电流 Maximum Reverse Recovery Current	5	/	A
QRR	反向恢复电荷 Reverse Recovery Charge	150	/	nc
TRR	反向恢复时间 Reverse Recovery Time	100	/	ns
IRRM	最大反向恢复电流 Maximum Reverse Recovery Current	9	/	A
QRR	反向恢复电荷 Reverse Recovery Charge	700	/	nc

■ 热特性 Thermal Characteristics @ Ta = 25°C unless otherwise noted

特征/测试条件 Characteristic / Test Conditions	符号 SYMBOL	典型值 TYP	最大值 MAX	单位 UNIT
结到管壳的热阻, 有散热片 Junction to case Thermal Resistance, with heat sink	RθJC	0.80	/	°C/W

■ 反向恢复测试方法 Diode Reverse Recovery Test Circuit and Waveform

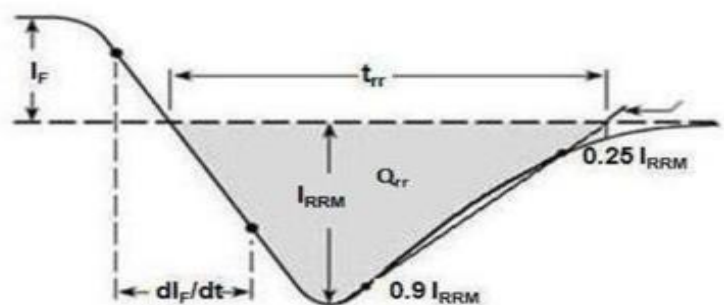
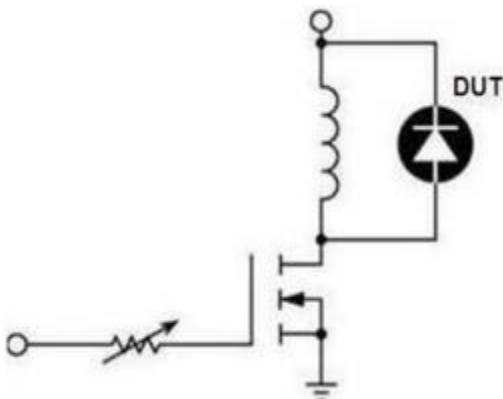


FIG.1 . Derating Curve For Output Rectified Current

图 1. 电流降额曲线

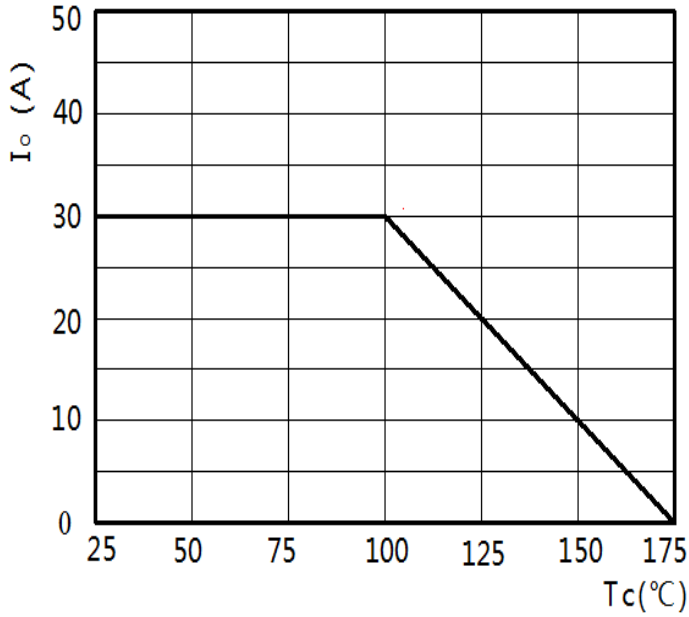


图 2. 最大正向不重复峰值浪涌电流

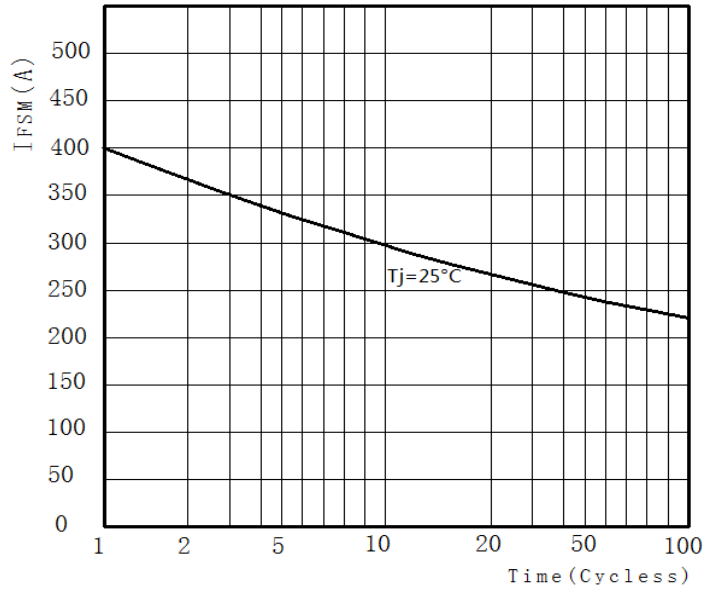


FIG3. Typical Reverse Characteristics Per Bridge Element

图 3. 典型反向特性

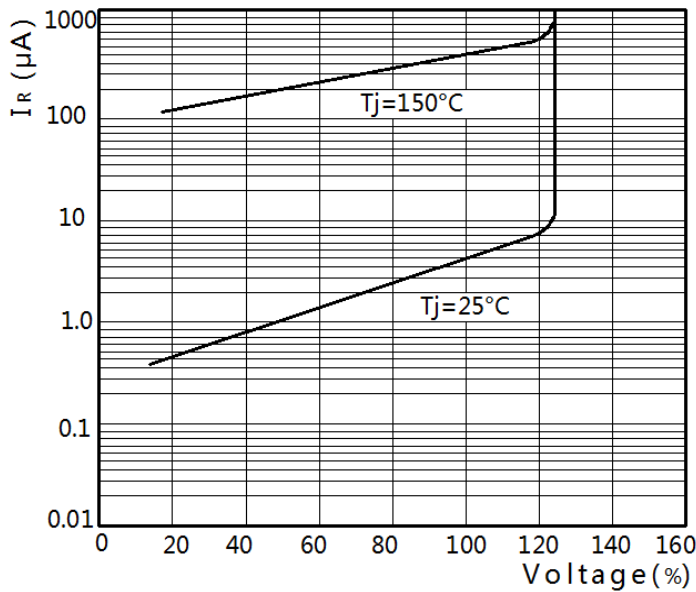


FIG4. Typical Forward Characteristics Per Bridge Element

图 4. 典型正向特性

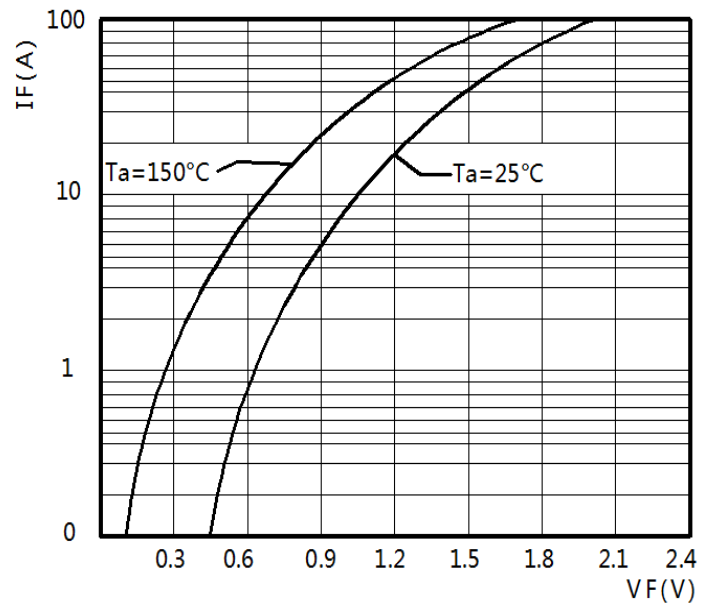


FIG.5 . Reverse Recovery Time VS diF /dt

图 5. 反向恢复时间

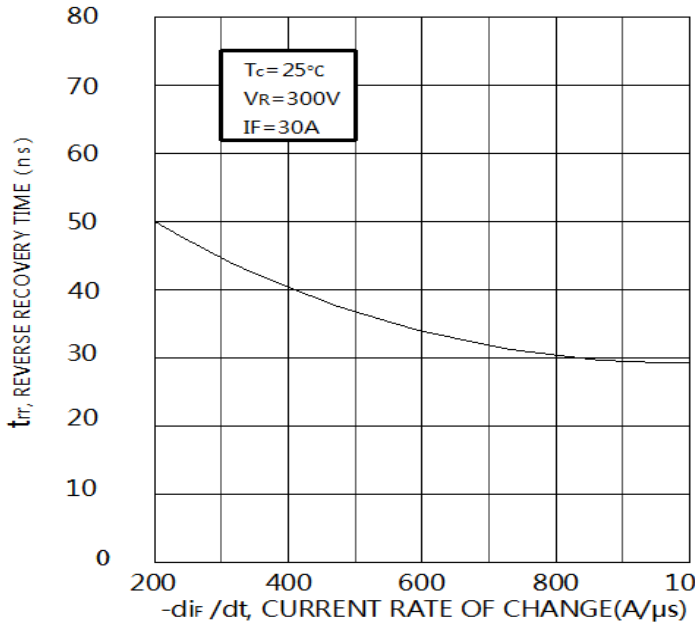


FIG.6 . Reverse Recovery Current VS diF /dt

图 6. 反向恢复电流

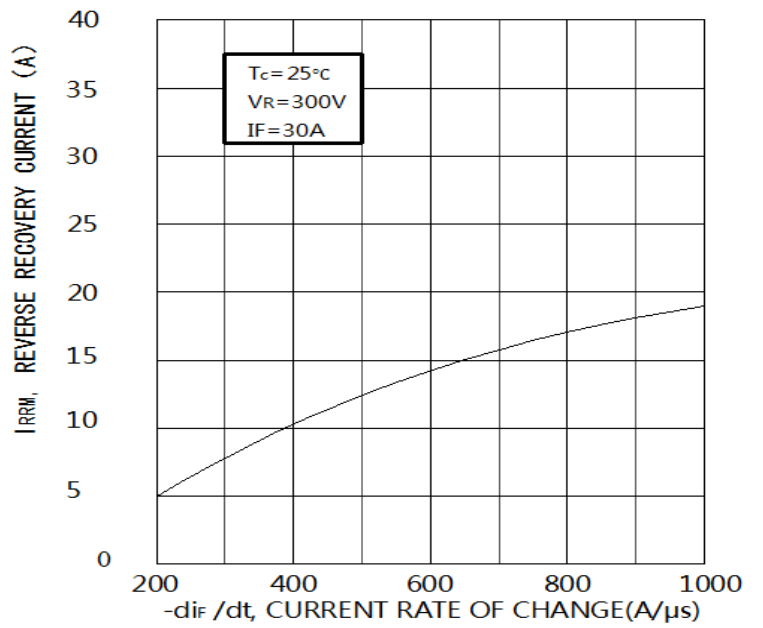
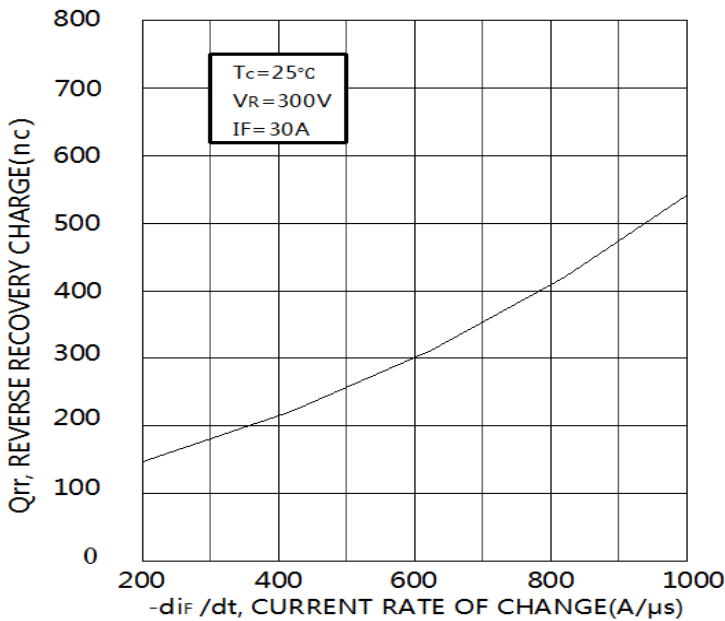
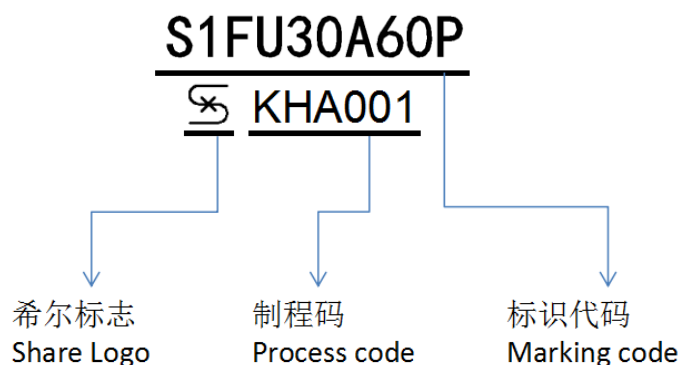


FIG7. Reverse Recovery Charge vs diF/dt

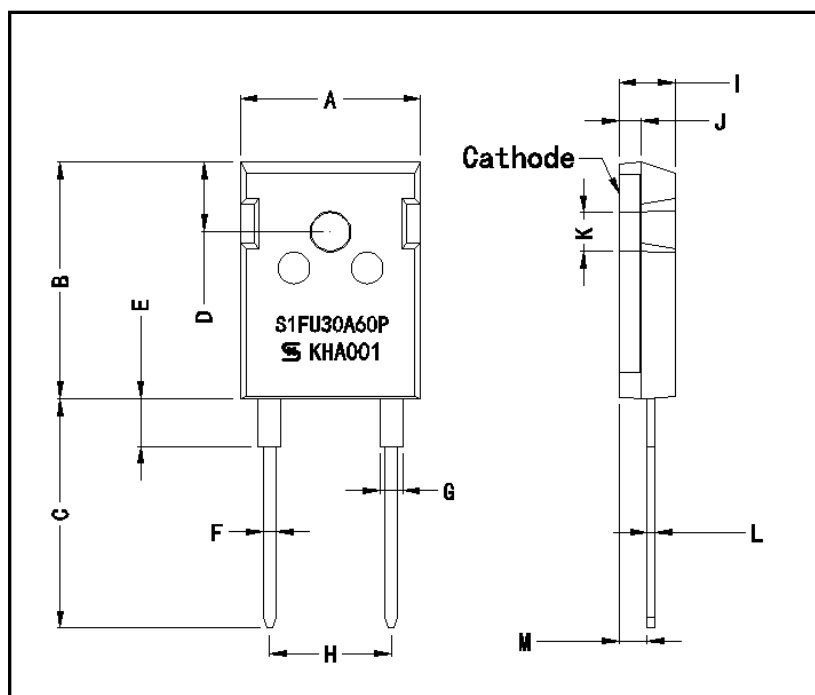
图 7. 反向重复峰值电流



■ 标记图 Marking Diagram



■ 尺寸图 Dimension Drawing



Dim.	Unit(mm)		Unit(inch)	
	min	max	min	max
A	15.70	16.30	0.62	0.64
B	20.70	21.30	0.81	0.84
C	19.50	20.50	0.77	0.81
D	5.70	6.70	0.22	0.26
E	4.00	4.40	0.16	0.17
F	1.00	1.40	0.04	0.06
G	1.70	2.30	0.07	0.09
H	10.5	11.1	0.20	0.23
I	4.70	5.30	0.19	0.21
J	1.70	2.30	0.07	0.09
K	3.20	3.80	0.13	0.15
L	0.50	0.70	0.02	0.03
M	2.20	2.60	0.09	0.10

Notice

The information presented in this document is for reference only. Leshan Share Electronic Co., Ltd. reserves the right to make changes without notice for the specification of the products displayed herein to improve reliability, function or design or otherwise.

本文档提供的信息仅供参考。为提高产品的可靠性、功能或设计等，乐山希尔电子股份有限公司保留对此产品规格进行更改的权利，恕不另行通知。