

伊顿是一家全球领先的动力管理公司，2013年销售额达220亿美元。伊顿致力于提供各种节能高效的解决方案，以帮助客户更有效、更安全、更具可持续性地管理电力、流体动力和机械动力。伊顿在全球拥有约10.1万名员工，产品销往超过175个国家和地区。如需更多信息，敬请访问公司中文网站[www.eaton.com.cn/electrical](http://www.eaton.com.cn/electrical)。

## 按钮和指示灯A22



伊顿公司  
亚太总部  
上海市长宁区临虹路280弄3号  
邮编: 200335  
[www.eaton.com.cn/electrical](http://www.eaton.com.cn/electrical)

© 2014 伊顿公司  
本公司保留对样本资料的解释权和  
修改权，并毋需另行通知。  
CHICA0103001\_CN (06-2014)

客户服务中心  
联系方式: 800-988-1203  
工作时间: 09:00-17:00 (周一至周五)  
技术服务邮箱: [TechCareCPCD@Eaton.com](mailto:TechCareCPCD@Eaton.com)

**EATON**  
Powering Business Worldwide

**EATON**  
Powering Business Worldwide

按钮和指示灯A22/A22M\*



\* A22: 前部亮光面环  
A22M: 前部亚光面环

按钮和指示灯A22/A22M\*

产品概览 .....	1
型号说明 .....	3
平齐安装成套按钮 .....	4
表面安装成套按钮, 紧凑型指示灯 .....	5
急停开关 .....	6
按钮头 .....	7
选择开关头 .....	8
钥匙操作开关头 .....	8
带灯按钮头 .....	9
指示灯 .....	9
固定支架, 触点模块 .....	10
灯座模块 .....	11
附件 .....	12
技术数据 .....	15
外形尺寸 .....	17

# 融合的力量

按钮和指示灯A22

- 符合标准IEC/EN 60947, VDE0660
- 模块化结构适配各种功能要求
- 无需工具即可进行安装
- 触点模块指触安全
- 每个安装部位最多可安装3个触点模块, 最多包含6副触点

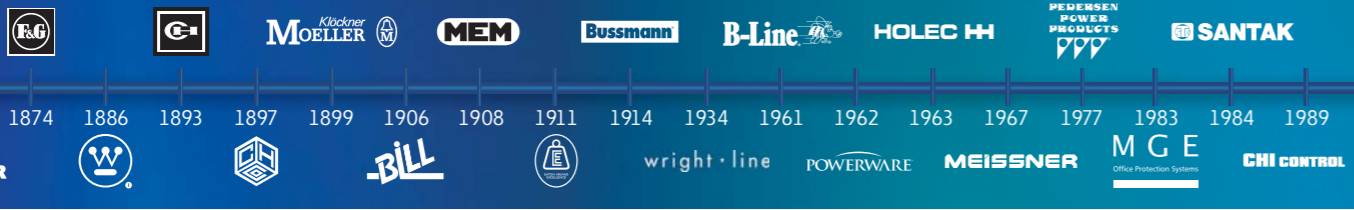

伊顿公司拥有融合众多世界知名品牌的力量, 将全球数家声誉卓著的企业纳入麾下, 塑造一个值得您信赖并满足您各种动力管理需求的品牌。

伊顿致力于为客户提供可靠、高效和安全的动力管理解决方案。基于一百多年以来丰富的电力管理经验, 伊顿的专家们将提供量身定制的电气解决方案, 解决您面临的关键问题。欲了解更多信息, 请访问: [www.eaton.com.cn/electrical](http://www.eaton.com.cn/electrical)。



以上徽标均为伊顿或其附属公司的商标。伊顿有权在亚太地区使用Westinghouse这一品牌名称。©2014年伊顿公司, 版权所有。



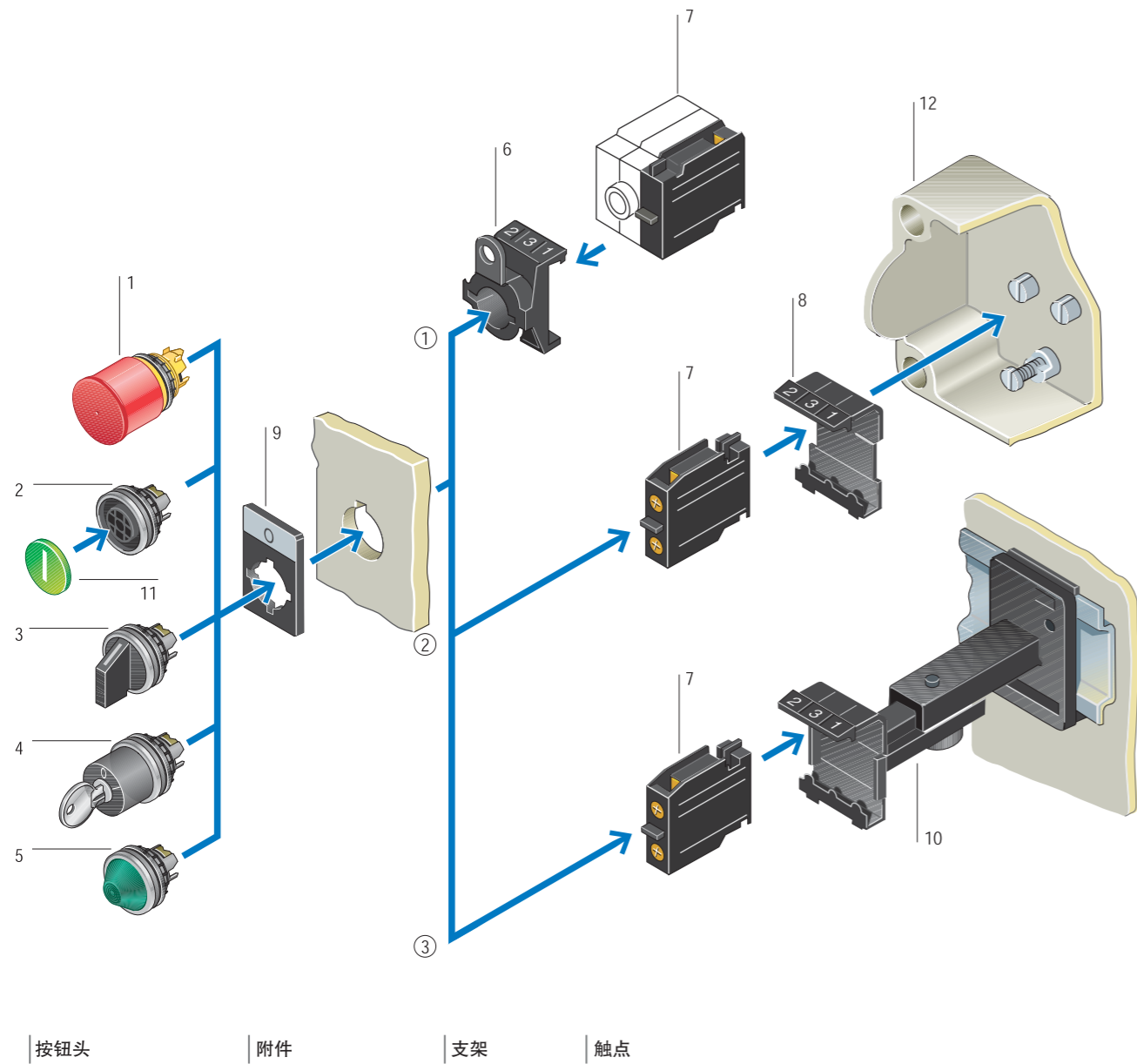

按钮头 | 附件 | 支架 | 触点

**急停开关头 1**  
带或不带文字标记的附加标志牌  
见第6页

**按钮头 2**  
弹簧复位和自锁定  
平头按钮  
蘑菇头按钮  
双位按钮  
带灯按钮带透明插入式指示牌  
颜色：白、绿、红、黄、蓝  
见第7页

**选择开关头 3**  
2位和3位  
带拇指操作手柄  
可以自行设定弹簧复位/自锁定功能  
颜色：黑  
见第8页

**钥匙操作开关头 4**  
2位或3位  
可以自行设定自锁定/弹簧复位功能和钥匙取出部位  
见第8页

**带灯按钮头/指示灯 5**  
平头和锥形头  
可用于白炽灯泡，氖泡和LED元件  
颜色：白、绿、红、黄、蓝  
见第9页

**固定支架 6**  
用于前部安装  
用于触点模块和灯座模块  
见第10页

**触点模块 7**  
带1个或2个触点  
适用于电子电路的通用触点  
通过强制分断，实现安全功能，符合IEC/EN 60947-5-1  
见第10页

**灯座模块 7**  
可用于白炽灯泡、氖泡和LED元件  
内配灯泡测试功能  
见第11页

**固定支架 8**  
用于表面安装和后部安装  
用于触点安装和灯座安装  
见第10页

**标志牌架 9**  
用于插入式标牌  
颜色：灰或黑  
铝制插入式，带和不带文字标记  
见第13页

**伸缩夹 10**  
用于调节在C按钮盒及在控制柜中后部安装元件的安装深度  
适用于安装深度125-157mm  
见第14页

**按钮标志牌/插入式标志牌 11**  
防磨损按钮标志牌，适用于按钮，选择开关和双位开关  
透明插入式标志牌，用于带灯按钮和平头指示灯  
带符号标记  
见第12页

**按钮盒 12**  
按钮盒符合IP65  
最多5个安装孔  
见第13页

**产品特性**

- 模块化结构，直接卡装
- 圆形外形
- 前部圆环镀铬
- 安装孔径：22.3mm
- 最小安装高度和宽度：30x40mm
- 防护等级前部IP65，后部IP20
- 每个安装部位最多可安装3个触点模块，最多包含6副触点
- 可工作于不同电压

**A22具有三种安装方式，以适应不同安装要求。**

- ① **平齐安装** 比如安装与控制台，利用前部固定支架连接前部元件与功能部件。
- ② **表面安装** 安装于绝缘外壳，利用底部固定支架来固定开关元件。
- ③ **后部安装** 利用底部固定支架安装于控制柜门，此时需用伸缩支架调整柜内深度，用中心适配器来保证当柜门关闭时所有按钮部件连接在一起。

A22按钮和指示灯





A22按钮和指示灯型号说明



注: 触点模块型号说明  
A22-EK10(C) = 1常开触点  
A22-EK10(C) = 1常闭触点  
A22-EC11 = 1常开、1常闭触点  
A22-EC20 = 2常开触点  
A22-EC02 = 2常闭触点

按钮 标牌	触点配置 ☞ = 通过强制分断而 实现的安全功能, 符合 IEC/EN 60947-5-1 N/O = 常开 N/C = 常闭	触点序号	颜色	型号 订货号	型号 订货号	标准 包装
<b>按钮, IP65</b>						
<b>平头按钮</b>						
	1 N/O		-	前部亮光面环 <b>A22-RD-11/K10</b> 261366	前部亚光面环 <b>A22M-RD-11/K10</b> 107489	5件
	1 N/C ☞		-	<b>A22-RD-10/K01</b> 261368	<b>A22M-RD-10/K01</b> 107490	5件
	1 N/O		-	<b>A22-RD-11/K11</b> 254405	<b>A22M-RD-11/K11</b> 107440	5件
	1 N/O		-	<b>A22-RD-10/K11</b> 254406		5件
	1 N/O		-	<b>A22-RD-01/K11</b> 90000060600051		5件
	1 N/O		-	<b>A22-RD-03/K11</b> 90000060600052		5件
	1 N/O		-	<b>A22-RD-04/K11</b> 90000060600053		5件
<b>蘑菇头按钮, IP65</b>						
	1 N/O		-	<b>A22-RP-GN11/K10</b> 254407		5件
<b>带灯双位按钮, IP65</b> 白色散射镜, 带24V白炽灯泡						
	1 N/O		-	<b>A22-QDDL-11/10/K11/F</b> 254408	<b>A22M-QDDL-11/10/K11/F</b> 107442	5件
<b>钥匙释放蘑菇头按钮, IP65</b> 带2把钥匙, 独立锁定机构KMS1						
	-		●	<b>A22-RPSR/K01</b> 254409	<b>A22M-RPSR/K01</b> 107443	5件
<b>带灯按钮, IP65</b> 平头, 带白炽灯BA 9s, 2.4 W/130 V 外接电压 230 V ( 配套EF灯座模块, 可选择6 V; 24 V; 110 V; 230 V LEDs )						
	1 N/O		○	<b>A22-RLT-WS/K10/FR</b> 254410		5件
	1 N/O		●	<b>A22-RLT-GN/K10/FR</b> 254411		5件
	1 N/C ☞		●	<b>A22-RLT RT/K01/FR</b> 254412		5件
<b>指示灯, IP65</b> 锥形头, 带白炽灯BA 9s, 2.4 W/130 V 外接电压 230V						
	-		○	<b>A22-RL-WS/FR</b> 254413		5件
	-		●	<b>A22-RL-GN/FR</b> 254414		5件
	-		●	<b>A22-RL-RT/FR</b> 254415		5件
	-		●	<b>A22-RL-GE/FR</b> 254416		5件

**按钮和指示灯A22**  
表面安装成套按钮, IP65

安装孔数目	触点配置 ⊖= 通过强制分断而实现的安全功能, 符合 IEC/EN 60947-5-1 N/O = 常开      N/C = 常闭	触点序号	按钮盒颜色	型号 订货号	标准包装
 按钮, IP65 平头按钮	1 N/O	1 N/C ⊖		<b>A22-RD-11/KC/I</b> 254417	1件
	1 N/O	1 N/C ⊕		<b>A22-RD-10/KC/I</b> 254418	1件

适用于

颜色

型号  
订货号

标准  
包装

**指示灯, 紧凑型, IP65**  
LED元件, 50000h



24V AC/DC

110V AC/DC

220V AC/DC

380V AC

○

●

●

●

●

○

●

●

●

●

○

●

●

●

●

○

●

●

●

●

**A22-LCLED24-W**  
108186

**A22-LCLED24-R**  
108187

**A22-LCLED24-G**  
108188

**A22-LCLED24-Y**  
108189

**A22-LCLED24-B**  
108190

**A22-LCLED110-W**  
108191

**A22-LCLED110-R**  
108192

**A22-LCLED110-G**  
108193

**A22-LCLED110-Y**  
108194

**A22-LCLED110-B**  
108195

**A22-LCLED220-W**  
116040

**A22-LCLED220-R**  
116039

**A22-LCLED220-G**  
116038

**A22-LCLED220-Y**  
116041

**A22-LCLED220-B**  
116037

**A22-LCLED380AC-W**  
108206

**A22-LCLED380AC-R**  
108207

**A22-LCLED380AC-G**  
108208

**A22-LCLED380AC-Y**  
108209

**A22-LCLED380AC-B**  
108210

**选择开关**



60°

1 N/O

1 N/C ⊖



●

**A22-RWKIR/K11**  
9000060600050

5件

**按钮和指示灯A22**  
成套急停开关, 急停开关头, 急停开关标志牌

触点	触点序号	按钮颜色	型号 订货号	标准包装
⊖= 通过强制分断而实现的安全功能, 符合 IEC/EN 60947-5-1 N/O = 常开      N/C = 常闭	1 N/O	1 N/C	 <b>A22-RPV/KC/I</b> 254419	1件



**急停开关头(直提复位), IP65**

急停按钮, 防止人为干扰, 符合ISO 13850/EN 418  
直提复位, 最多可安装的触点模块数目: 3 × A22-EK...C



**急停开关头(旋转复位), IP65**

最多可安装的触点模块: 2 × A22-EK...; 2 × A22-EC...;  
3 × A22-EK...C



**蘑菇头钥匙释放急停开关头, IP65**

带2把钥匙,  
独立锁定机构KMS1,  
统一钥匙



描述

语言

颜色

型号  
订货号

标准  
包装

**急停开关标志牌, IP65**



空白

EMERGENCY STOP

紧急停机

英文

中文

●

●

●

**A22-1AK**  
254497

**A22-1AK-299**  
254498

**A22-1AK-299CN**  
90000060600024

10件







10件

10件





## 按钮和指示灯A22

按钮头，双位按钮头，蘑菇头

按钮头, IP65 平头按钮	按钮标牌/蘑菇头 头部符号	颜色	型号 订货号	标准 包装
		-	<b>A22-RD-11</b> 254420	10件
		-	<b>A22-RD-10</b> 254421	10件
		-	<b>A22-RD-01</b> 9240670000030	10件
		-	<b>A22-RD-03</b> 9240670000028	10件
		-	<b>A22-RD-04</b> 9240670000029	10件
	无	-	<b>A22-RD-X</b> 254422	10件
		-	<b>A22-RD-53</b> 90000060600021	10件







双位按钮头, IP65 白色散射镜 带灯功率: 最大至2W	按钮标牌/蘑菇头 头部符号	颜色	型号 订货号	标准 包装
		-	<b>A22-QDDL-11/10</b> 254423	5件
		-	<b>A22-QDDL-11/11</b> 90000060600010	5件
		-	<b>A22-QDDL-11/11</b> 90000060600010	5件
		-	<b>A22-QDDL-01/01</b> 90000060600049	5件
		-	<b>A22-QDDL-32/32</b> 90000060600022	5件







蘑菇头按钮头, IP65 弹簧复位	按钮标牌/蘑菇头 头部符号	颜色	型号 订货号	标准 包装
		●	<b>A22-RP-GN11</b> 254424	5件
		●	<b>A22-RP-RT10</b> 254425	5件

凸头按钮, IP65 弹簧复位	按钮标牌/蘑菇头 头部符号	颜色	型号 订货号	标准 包装
		●	<b>A22-RDH-GN11</b> 90000060600013	5件
		●	<b>A22-RDH-RT10</b> 90000060600014	5件
		●	<b>A22-RDH-SW01</b> 90000060600015	5件
	无	●	<b>A22-RDH-GNX</b> 90000060600016	5件
	无	●	<b>A22-RDH-RTX</b> 90000060600017	5件
	无	●	<b>A22-RDH-SWX</b> 90000060600018	5件



## 按钮和指示灯A22



选择开关头，钥匙操作开关头

选择开关头, IP65 2位	功能	钥匙抽出 位置	颜色	型号 订货号	标准 包装
拇指手柄		60°	●	<b>A22-RWK1R</b> 254428	5件
		45°	●	<b>A22-RWK1</b> 254429	5件
长手柄		60°	●	<b>A22-RWH1R</b> 111728	5件
		45°	●	<b>A22-RWH1</b> 111727	5件
		90°	●	<b>A22-RWH1V</b> 111729	5件
自锁定, 不能用编码组件改变		90°	●	<b>A22-RWK1V</b> 261369	5件

3位	功能	颜色	型号 订货号	标准 包装	
拇指手柄	60° 	60°	●	<b>A22-RWK3R</b> 254430	5件
	45° 	45°	●	<b>A22-RWK3</b> 254431	5件
长手柄	60° 	60°	●	<b>A22-RWH3R</b> 111744	5件
	45° 	45°	●	<b>A22-RWH3</b> 111743	5件
	60° 	45°	●	<b>A22-RWH3R1</b> 111745	5件
	60° 	60°	●	<b>A22-RWH3R2</b> 111746	5件

### 钥匙操作开关头, IP65

2位	功能	颜色	型号 订货号	标准 包装	
独立锁定机构, 统一钥匙, 带2把钥匙 自锁定/弹簧复位功能和钥匙抽出部位可以用编码组件 A22-SP-RMQ设定和改变。锁定机构KMS1。					
		60°	I 0 -	<b>A22-RS</b> 254432	5件
		45°	0	<b>A22-RS-KMS1-A2</b> 9240670000031	5件

3位	功能	颜色	型号 订货号	标准 包装	
独立锁定机构, 统一钥匙, 带2把钥匙 可安装2个触点模块 自锁定/弹簧复位功能和钥匙抽出部位可以用编码组件 A22-SP-RMQ设定和改变。					
	60° 	60°	I 0 II -	<b>A22-RS3</b> 254433	5件
	45° 	45°	0 -	<b>A22-RS3-KMS1-A4</b> 254434	5件



















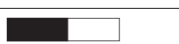

颜色	型号 订货号	标准 包装
<b>带灯按钮头, IP65</b> 前部圆环镀铬, 内部白色扩散片图形可订制		
<b>平头</b>		
弹簧复位		
	① <b>A22-RLT-WS11</b> 254435	10件
	○ <b>A22-RLT-WS</b> 254436	10件
	● <b>A22-RLT-GN</b> 254437	10件
	● <b>A22-RLT-RT</b> 254438	10件
	● <b>A22-RLT-GE</b> 254439	10件
	● <b>A22-RLT-BL</b> 9240470000050	10件
自锁定 带灯功率: 最大至1.2W		
	○ <b>A22-RLTR-WS</b> 254445	5件
	● <b>A22-RLTR-GN</b> 254446	5件
	● <b>A22-RLTR-RT</b> 254447	5件
	● <b>A22-RLTR-GE</b> 254448	5件
<b>凸头</b>		
		
	弹簧复位	自锁定
	① <b>A22-RLTH-WS11</b> 254440	<b>A22-RLTHR-WS11</b> 90000060600001
	○ <b>A22-RLTH-WS</b> 254441	<b>A22-RLTHR-WS</b> 90000060600002
	● <b>A22-RLTH-GN</b> 254442	<b>A22-RLTHR-GN</b> 90000060600003
	● <b>A22-RLTH-RT</b> 254443	<b>A22-RLTHR-RT</b> 90000060600004
	● <b>A22-RLTH-GE</b> 254444	<b>A22-RLTHR-GE</b> 90000060600005
	● <b>A22-RLTH-BL</b> 90000060600006	<b>A22-RLTHR-BL</b> 90000060600006
<b>指示灯, IP65</b>		
<b>平头</b> 无前部圆环		
		
	○ <b>A22-RLF-WS</b> 262645	10件
	● <b>A22-RLF-GN</b> 262653	10件
	● <b>A22-RLF-RT</b> 262654	10件
	● <b>A22-RLF-GE</b> 262655	10件
	● <b>A22-RLF-BL</b> 262656	10件
<b>锥形头</b> 前部圆环镀铬		
		
	○ <b>A22-RL-WS</b> 254449	25件
	● <b>A22-RL-GN</b> 254450	25件
	● <b>A22-RL-RT</b> 254451	25件
	● <b>A22-RL-GE</b> 254452	25件
	● <b>A22-RL-BL</b> 1433001011511	25件



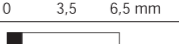

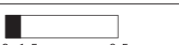

触点  
M = 常开, B = 常闭  
⊕ = 通过强制分断而  
实现的安全功能, 符合  
IEC/EN 60947-5-1

触点序号 电路图 配置

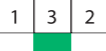

型号  
订货号 标准  
包装

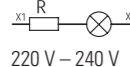
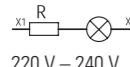
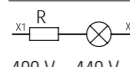
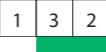

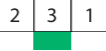
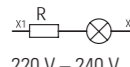
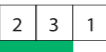













固定支架	触点	触点序号	电路图	配置	型号 订货号	标准 包装	
<b>平齐安装</b> 用于A22-EK, A22-EC, A22-EF(R), 触点模块及灯座模块 固定支架上有顺序号							
	-	-		$\frac{1}{2}$ $\frac{5}{6}$ $\frac{4}{3}$	<b>A22-BE6</b> 254453	10件	
<b>表面/后部安装</b> 用于A22-E...C触点模块 固定支架上有顺序号							
	-	-		2 3 1	<b>A22-BE3C</b> 254461	25件	
<b>触点模块</b>							
<b>平齐安装</b>							
1个触点 用于A22-BE6固定支架							
	1 M				$\frac{1}{4}$ $\frac{3}{6}$ $\frac{2}{5}$	<b>A22-EK10</b> 254454	20件
	1 B ⊕				$\frac{1}{4}$ $\frac{3}{6}$ $\frac{2}{5}$	<b>A22-EK01</b> 254455	20件
	1 M				$\frac{1}{4}$ $\frac{3}{6}$ $\frac{2}{5}$	<b>A22-EK10P</b> 36531	20件
	1 B ⊕				$\frac{1}{4}$ $\frac{3}{6}$ $\frac{2}{5}$	<b>A22-EK01R</b> 41277	20件
2个触点 用于A22-BE6固定支架							
	1 M	1 B ⊕			$\frac{1}{2}$ $\frac{5}{6}$ $\frac{4}{3}$	<b>A22-EC11</b> 254456	10件
	2 M				$\frac{1}{2}$ $\frac{5}{6}$ $\frac{4}{3}$	<b>A22-EC20</b> 254457	10件
	2 B ⊕				$\frac{1}{2}$ $\frac{5}{6}$ $\frac{4}{3}$	<b>A22-EC02</b> 254458	10件
<b>表面/后部安装</b>							
1个触点 用于A22-BE3C固定支架							
	1 M				2 3 1	<b>A22-EK10C</b> 254462	20件
	1 B ⊕				2 3 1	<b>A22-EK01C</b> 254463	20件

配置说明  
带序号的固定支架的配置, 符合EN 50013  
 $\begin{matrix} |_{xy} \\ |_{xy} \end{matrix}$  x = 固定支架上的位置号  
 $\begin{matrix} |_{xy} \\ |_{xy} \end{matrix}$  y = 触点模块上的位置号

触点序号	灯泡电压, 电阻	配置	型号 订货号	标准 包装
<b>灯座模块 BA 9s</b>				
不带灯泡, 用于A22-BE6固定支架				
<b>平齐安装</b>				
适用于白炽灯, 氖泡, LED元件, 用于支架A22-BE6				
	 max. 250 V	⊗ BA 9s, max. 2 W, U <sub>i</sub> = 250 V	 1 3 2	<b>A22-EF</b> 254459 10件
	 220 V – 240 V	⊗ BA 9s, 2.6 W/130 V, U <sub>i</sub> = 250 V, R = 7.5 k Ω	 1 3 2	<b>A22-EFR</b> 254460 10件
	 220 V – 240 V	⊗ BA 9s, LED/6V, U <sub>i</sub> = 250 V, R = 43 k Ω	 1 3 2	<b>A22-EFR(230V/6V)</b> 1433001011815 10件
	 400 V – 440 V	⊗ BA 9s, LED/6V, U <sub>i</sub> = 500 V, R = 100 k Ω	 1 3 2	<b>A22-EFR(415V/6V)</b> 1433001011814 10件
<b>表面/后部安装</b>				
适用于白炽灯, 氖泡, LED元件, 用于支架A22-BE3C				
	 max. 250 V	⊗ BA 9s, max. 2 W	 2 3 1	<b>A22-EFC</b> 254464 10件
	 220 V – 240 V	⊗ BA 9s, 2.6 W/130 V, U <sub>i</sub> = 250 V, R = 7.5 k Ω	 2 3 1	<b>A22-EFRC</b> 254465 10件
适用于		颜色	型号 订货号	标准 包装





<b>白炽灯泡 BA 9s</b>				
最长28mm, 10mm				
	110...130 V/2.4 W	–	<b>A22-GL130</b> 261361	100件
	24 V/2.0 W	–	<b>A22-GL24</b> 261360	100件

<b>LED元件 BA 9s</b>				
AC和DC电压, (正极连接到X1), 防止极性反向, 内置抑制电路至1500V, 10000h				
	18...30 V AC/DC, 15 mA		<b>A22-LED-W</b> 261362	10件
			<b>A22-LED-R</b> 261364	10件
			<b>A22-LED-G</b> 261363	10件
			<b>A22-LED-Y</b> 261365	10件
	240V AC/DC		<b>A22-LED230-BA9S-W</b> 111509	
			<b>A22-LED230-BA9S-R</b> 111510	
			<b>A22-LED230-BA9S-G</b> 111511	
			<b>A22-LED230-BA9S-Y</b> 111512	
			<b>A22-LED230-BA9S-B</b> 111513	

符号, 颜色	型号 订货号	标准 包装
<b>标志牌</b>		
符号 符合DIN 30600	停止	
	开始	
	开始	
	开始	
	开始	
	停止或关闭	
	起动或接通	
	增加	
	减少	
	移动方向	
空白		
		
		
		
		
		



符号	颜色	型号 订货号	标准 包装				
<b>带插入牌的标志牌架</b> 铝色面板，插入式，文字黑色，标牌激光订制							
	—	<b>A22-RAS-32</b> 254488	25件				
	—	<b>A22-RAS-33</b> 254489	25件				
0-I	—	<b>A22-RAS-90</b> 254490	25件				
I-0-II	—	<b>A22-RAS-93</b> 254491	25件				
0-I	—	<b>A22-RAS-98</b> 254492	25件				
STOP	—	<b>A22-RAS-110</b> 254493	25件				
START	—	<b>A22-RAS-111</b> 254494	25件				
MAN-AUTO	—	<b>A22-RAS-395</b> 254495	25件				
MAN-0-AUTO	—	<b>A22-RAS-397</b> 254496	25件				
<b>无插入牌的标志排架</b>							
型号...A...	宽 × 高: 30 × 40mm	—	●	<b>A22-RAS-X</b> 254486	25件		
	宽 × 高: 30 × 50mm	—	●	<b>A22-RBS-X</b> 271391	25件		
<b>插入牌</b> 铝色面板，可以激光打印							
	宽 × 高: 26.7 × 8mm	—	—	<b>A22-XA</b> 254487	100件		
	宽 × 高: 26.7 × 17.8mm	—	—	<b>A22-XB</b> 90000060216480	100件		
安装孔数	电缆输入敲落孔	可同时安装的 灯泡数	颜色	型号 订货号	价格 见价格表	标准 包装	
	底部 数量 × M...	侧面 数量 × M...	数量				
<b>表面安装按钮盒IP65</b>							
用于急停开关	1	1 × 13.5	3 × 16	1	●	<b>A22-IGE1M</b> 254499	1件
	1	1 × 13.5	3 × 16	1	●	<b>A22-I1M</b> 254500	1件
	2	2 × 13.5	3 × 16	2	●	<b>A22-I2M</b> 254501	1件
	3	2 × 13.5	4 × 16	3	●	<b>A22-I3M</b> 254502	1件
	4	2 × 13.5	4 × 16	4	●	<b>A22-I4M</b> 254503	1件
	5	2 × 13.5	4 × 16	5	●	<b>A22-I5M</b> 255802	1件

适用于	颜色	型号 订货号	标准 包装	
<b>封堵元件</b> 用于封堵备用安装部位				
 圆形	●	<b>M22-B</b> 216388	50件	
<b>伸缩夹</b> 用于调节在CI按钮盒及在柜体中后部安装元件的深度，调节范围125-157mm。利用标尺可在64-95mm内连续调节。螺钉或卡装固定，利用A22-BE3C固定支架来固定后部元件。一个CI按钮盒最多使用10个A22-TC-RMQ，其中5个可以安装自锁式按钮。不能用于急停开关。				
	—	<b>A22-TC-RMQ</b> 254504	5件	
<b>电缆护套PG13.5 IP68, 69K</b> 电缆外径6-12mm				
	—	<b>STBZ13,5</b> 036307	20件	
<b>套筒扳手</b> 内部环状螺纹，可配装电动螺丝刀 用于A22或M22系列按钮				
	—	<b>M22-MS</b> 216402	5件	
<b>编码组件</b> 用于设定和改变自锁定/弹簧复位功能和钥匙取出部位，由2个部件组成。				
		●	<b>A22-SP-RMQ</b> 254507	5件
		●	<b>A22-SP-RMQ</b> 254507	5件
		●	<b>A22-SP-RMQ</b> 254507	5件
标记说明:  锁定  弹簧复位				

	单位	按钮, 蘑菇头按钮	双位按钮 <sup>1)</sup>	选择开关	钥匙释放开关
<b>概述</b>					
符合标准		IEC/EN 60947, VDE 0660			
机械寿命	通断次数 × 10 <sup>6</sup>	> 5	> 2	> 1	> 1
通断操作频率	操作次数/h	≤ 6000	≤ 6000	≤ 2000	≤ 100
操作力	Nm	≤ 5	≤ 5	-	-
防护等级		IP65	IP65	IP65	IP65
气候防护		湿热, 持续, 符合IEC 60068-2-78; 湿热, 循环, 符合IEC 60068-2-30			
<b>环境温度</b>					
敞开	°C	-25/60	-25/60	-25/60	-25/60
密闭	°C	-25/40	-25/40	-25/40	-25/40
安装位置		任意	任意	任意	任意
机械冲击耐受, 冲击持续时间 11 ms	g	> 30	> 30	> 30	> 30

注: 1) 技术数据仅适用于⊗至1.2W

	单位	指示灯	带灯按钮, 自锁定 <sup>2)</sup>	蘑菇头钥匙释放 开关	急停开关
<b>概述</b>					
符合标准		IEC/EN 60947, VDE 0660			
机械寿命	通断次数 × 10 <sup>6</sup>	> 3	> 3 <sup>3)</sup>	> 1	> 1
通断操作频率	操作次数/h	-	≤ 6000	≤ 100	≤ 600
操作力	Nm	≤ 5	≤ 5	≤ 7	≤ 50
防护等级		IP65	IP65	IP65	IP65
气候防护		湿热, 持续, 符合IEC 60068-2-78; 湿热, 循环, 符合IEC 60068-2-30			
<b>环境温度</b>					
敞开	°C	-25/60	-25/60	-25/60	-25/60
密闭	°C	-25/40	-25/40	-25/40	-25/40
安装位置		任意	任意	任意	任意
机械冲击耐受, 冲击持续时间 11 ms	g	-	> 30	> 30	> 50

注: 1) 技术数据仅适用于⊗至1.2W

3) A22-RLTR的机械寿命是: 0.3 × 10<sup>6</sup>

	单位	触点 模块	灯座 模块
<b>概述</b>			
符合标准		IEC/EN 60947, VDE 0660	
机械寿命	通断次数 × 10 <sup>6</sup>	> 10	-
操作频率	操作次数/h	≤ 6000	-
操作力	Nm	≤ 5 A22-EC11: ≤ 7.3 A22-EC20: ≤ 9 A22-EC02: ≤ 5.5	-
防护等级		IP20	IP20
气候防护		湿热, 持续, 符合IEC 60068-2-78; 湿热, 循环, 符合IEC 60068-2-30	
<b>环境温度</b>			
敞开	°C	-25/60	-25/60
密闭	°C	-25/40	-25/40
安装位置		任意	任意
机械冲击耐受, 冲击持续时间11ms	g	> 30	> 30

	单位	触点 模块	灯座 模块
<b>接线横截面</b>			
单芯线		0.75 - 2.5	0.75 - 2.5
多股软线		0.5 - 1.5	0.5 - 1.5

	单位	触点 模块	灯座 模块
<b>触点</b>			
额定冲击耐受电压	U <sub>imp</sub>	V AC	6000
额定绝缘电压	U <sub>i</sub>	V	500
过压类别/污染等级		III/3	III/3
<b>控制回路可靠性</b>			
于5 V DC/1 mA	H <sub>F</sub>	< 5 × 10 <sup>6</sup> , 5 × 10 <sup>6</sup> 次操作, 少于一次故障	
于24 V DC/5 mA	H <sub>F</sub>	< 10 <sup>7</sup> , 10 <sup>7</sup> 次操作, 少于一次故障	

	单位	触点 模块	灯座 模块
<b>最大短路保护装置</b>			
无熔断器	型号	PKZM0-10/FAZ-B6	-
有熔断器	gG/gL	A	10

<b>分断能力</b>				
额定工作电流				
AC - 15				
115V	I <sub>e</sub>	A	6	-
230V	I <sub>e</sub>	A	6	-
400V	I <sub>e</sub>	A	4	-
500V	I <sub>e</sub>	A	2	-
DC - 13				
24V	I <sub>e</sub>	A	3	-
60V	I <sub>e</sub>	A	3	-
110V	I <sub>e</sub>	A	0.8	-
220V	I <sub>e</sub>	A	0.3	-

<b>电气寿命</b>				
AC - 15				
230V/0.5A	通断次数	× 10 <sup>6</sup>	1.6	-
230V/1.0A	通断次数	× 10 <sup>6</sup>	1	-
230V/3.0A	通断次数	× 10 <sup>6</sup>	0.7	-
DC - 13				
12V/2.8A	通断次数	× 10 <sup>6</sup>	1.2	-

按钮和指示灯

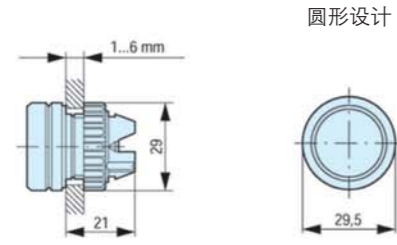

开孔尺寸

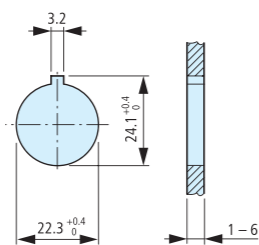

按钮

A22-RD-...

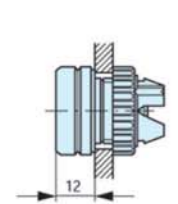

A22-QDDL-...

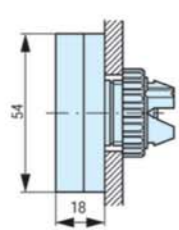

选择开关

A22-RWK-...

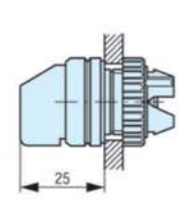

钥匙释放开关

A22-RS-...

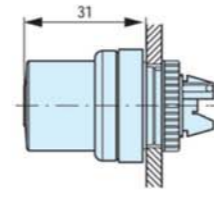

指示灯

A22-RL-...

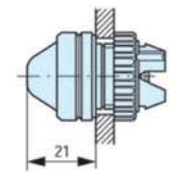

A22-RLF-...

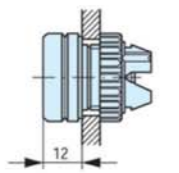

带灯按钮

A22-RLT-...  
A22-RLTR-...

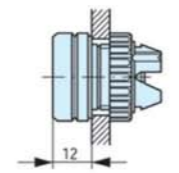

A22-RLTH-...

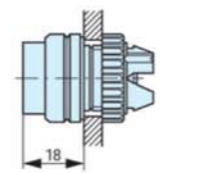

蘑菇头钥匙释放开关

A22-RP-...

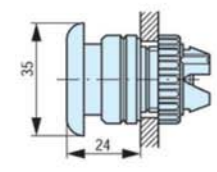

A22-RPSR-...

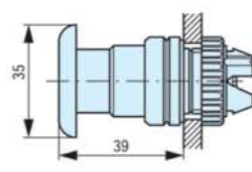

急停开关

A22-RPV-...

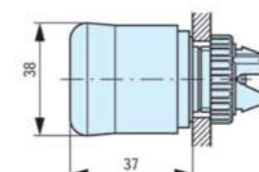

A22- E•STOP HEADER

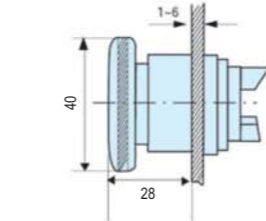

前部固定 (形式: 平齐安装)

固定支架

A22-BE3

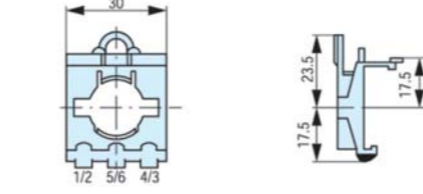

按钮带 A22-EK...

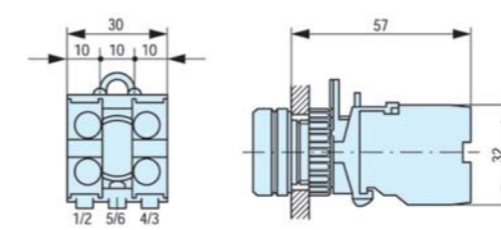

按钮带 A22-EC...

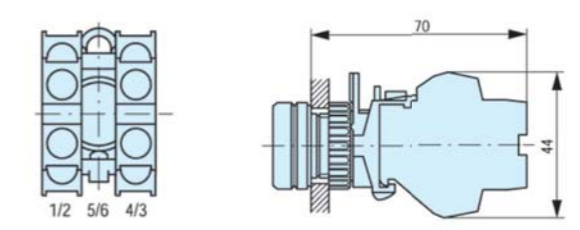

指示灯/带灯按钮

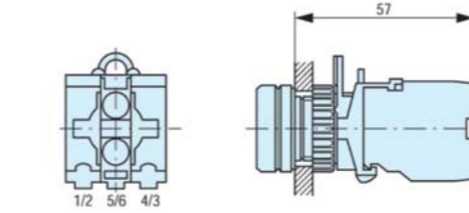

紧凑型指示灯 A22-LCLED

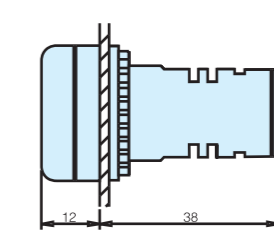

后部固定 (形式: 表面/后部安装)

固定支架

A22-BE3C

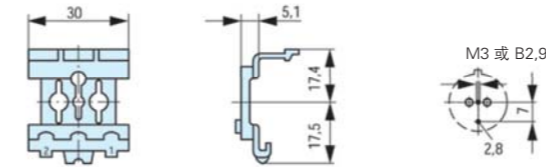

按钮

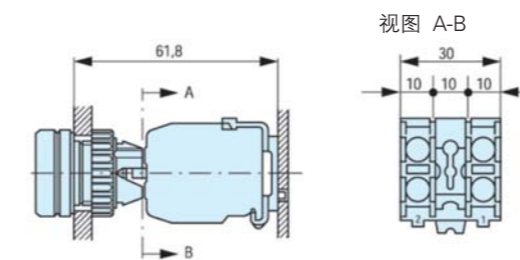

指示灯/带灯按钮

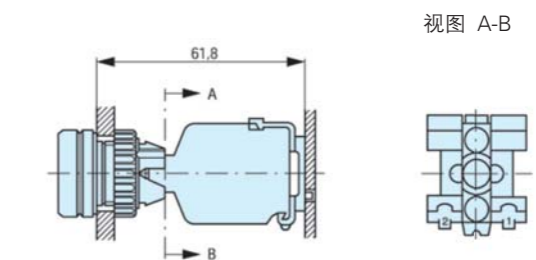



## 按钮和指示灯A22

### 外形尺寸

#### 后部固定 (表面安装)

#### 表面安装按钮盒

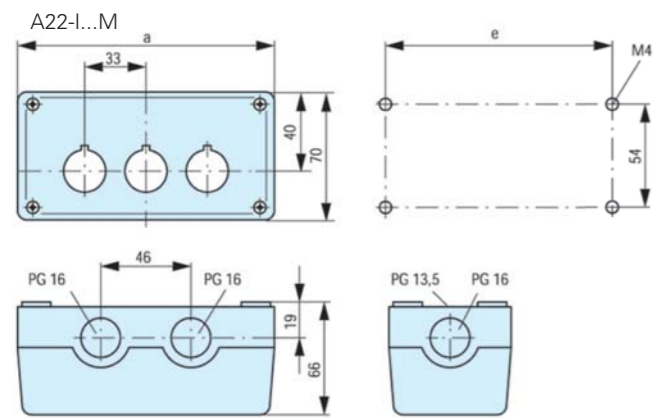

型号	安装孔数目	a	e	敲落孔	
A22-I (GE) 1 M	1	72	54	3 × PG 16	1 × PG 13,5
A22-I 2 M	2	120	100	3 × PG 16	2 × PG 13,5
A22-I 3 M	3	153	133	4 × PG 16	2 × PG 13,5
A22-I 4 M	4	186	166	4 × PG 16	2 × PG 13,5
A22-I 5 M	5	219	200	4 × PG 16	2 × PG 13,5

#### 急停标志牌

#### A22-1AK

