



高压固态软起动装置说明书

说 明 书

型号：SPHMOV

襄阳赛克斯电气股份有限公司

- 请仔细阅读说明手册，理解各项内容，以便能正确的安装、电路连接、运行操作和保养维护等。
- 本产品技术规范可能发生变化，恕不另行通知。
- 本说明手册应一直保存到本产品报废时为止。
- 本说明手册应保存在实际最终使用人的手中。

- Please read through the instruction manual so as to properly carry out installation, circuit connection, operation and maintenance.
- Specifications of this product is subject to change, without prior notice.
- This instruction manual should be properly kept until the product is of service.
- This instruction manual should be kept by real users.

目 录 (*Table of Contents*)

第一章 概述 (General Introduction)	4
1.1 型号说明 (Description of model)	4
1.2 技术指标 (Technical indicators)	5
1.3 一次方案(Diagram of major loop)	7
1.4 设计结构 (Design structure)	7
1.5 总体结构 (General structure)	8
1.6 工作原理 (Operating Principles)	9
1.7 技术特点 (Technical characteristics)	10
第二章 操作说明 (Operating Instructions)	12
2.1 面板说明 (Panel introduction)	12
2.2 工作原理及操作流程 (Operating principle and process)	12
第三章 安装 (Installation)	16
3.1 产品规格及外形尺寸 (Specification and dimension)	16
3.2 接收和开箱 (Acceptance and unpacking)	17
3.3 安装 (Installation)	17
3.4 设备附加改造 (Additional reconstruction of the equipment)	18
第四章 LCD 显示器的操作 (Operation of LCD Display)	19
4.1 按键功能说明 (Functional description of keys)	19
4.2 修改参数项操作流程 (Operation flow for altering parameter items)	19
第五章 起动 (Start)	21
5.1 低压测试步骤 (Procedures for low voltage test)	21
5.2 高压测试步骤 (Procedures for high voltage test)	22
5.3 软起动控制模式 (Control mode of soft start)	22
5.4 参数项及其说明 (Parameters and Description)	29
5.5 软起动装置控制参数表 (Control parameter list of soft starter)	29
第六章 维护及故障排除 (Maintenance and Troubleshooting)	43
6.1 故障分析(Fault analysis)	43
6.2 故障代码(Fault code)	43
6.3 故障记录 (Fault history)	45
6.4 故障清除 (Troubleshooting)	45
6.5 日常维护 (Maintenance)	46
第七章 附加说明 (Additional Information)	47
7.1 订货须知 (Order information)	47
接线原理图 (schematic diagram of wiring)	48

安全使用注意事项

Attentions on safety

在安装，电路连接（配线），运行，维护检查前，必须熟悉本操作说明内容，以保证正确使用，使用时必须熟知驱动机械的情况和一切有关安全和注意事项。

To ensure proper use of this device, you must be read through the operating instructions before installation, operation and maintenance. In the course of operating, you must get familiar with mechanical drive conditions and others relating to safety.



安全 *Safety*

- 操作本设备之前，请仔细阅读本产品说明书并严格按照该说明书进行操作。
- 安装及维护操作，应严格按照本说明书及相关国家标准及行业惯例，否则因没有按照相应指导规范操作所引起的一切不良后果制造商概不负责。
- 维护软起动装置或电机之前，必须断开一切电源输入。
- 安装后应仔细检查核实无任何零部件落入带电器件部位。
- Please read these instruction carefully before using this soft starter and operate the device strictly in accordance with operating instructions;
- Installation and maintenance must be done strictly in accordance with these instructions and standards of the relative countries; we shall assume to responsibility, either directly or indirectly, for any action associated with the use of our products;
- Power must be cut off before maintenance is done to soft starter or motor;
- Please carefully check if any spare part is left inside soft starter after assembly.

- 本产品与主电源连接后其内部局部器件所带的电压等同于主电源电压，若违规接触它将非常危险，可引起触电伤亡事故。
- SEC-SPHMV的负载端不允许接入电容功率因数补偿器、压敏电阻，会引起冲击电流，起动时会损坏SCR。不要试图修理损坏的器件，请与供货商联系。
- 软起动装置与变频器混用时，二者输出端要彼此隔离。
- After this soft starter is connected to power supply,the voltage of certain elements inside the soft starter is equal to that of power supply. It will be dangerous to touch them with hand and may cause serious hurt to your body;
- SEC - SPHMV load end is not allowed to be connected with capacitor power-factor compensator and piezoresistor for fear of causing impact current, which may damage SCR in starting. Do not attempt to repair damaged elements and contact your supplier please.
- When soft starter is used together with frequency converter, their

第一章 概述

Section I General Introduction

SEC-SPHMV 系列高压固态软起动装置(以下简称软起动装置)是采用最新理念设计的高压电机软起动装置,主要适用于鼠笼式异步、同步电动机起动和停止的控制与保护。该装置采用多个可控硅串并联而成,可满足不同的电流及电压要求。

SEC - SPHMV series high voltage solid soft starter (hereinafter referred to as soft starter) is a high voltage motor soft starter designed with up-to-date concept, and mainly applicable to the control of and protection for the starting and stopping of squirrel-cage type asynchronous and synchronous motors. The starter is composed of several thyristor in series-parallel, and it can meet different current and voltage requirements.

产品广泛应用于额定电压 3000—10000V 的电力、建材、化工、冶金钢铁、造纸等行业。能很好地与水 泵、风机、压缩机、粉碎机、搅拌机、皮带机等各种机电设备配套使用,是理想的高压电机起动及保护设备。

The Product is widely used in electric industry with rated voltage 3000 to 10000 V, building materials, chemical industry, metallurgy, steel and paper-making industries etc.. And can perform well if used together with various kinds of electromechanical devices including water pumps, fans, compressors, crashes, agitators and conveyer belt etc.. It is the ideal device for starting and protecting high voltage motors.

1.1 型号说明 (Description of model)

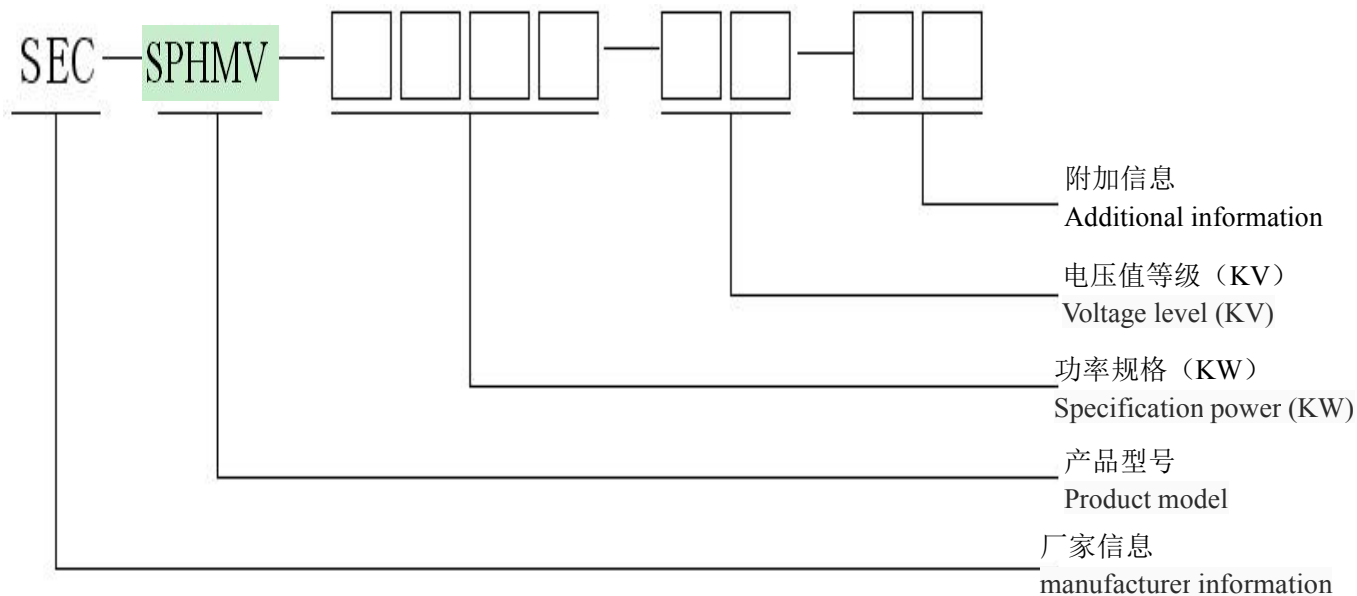

1.2 技术指标 (Technical indicators)

基本参数 Basic parameters	
负载种类 Type of load	三相高压鼠笼式异步电机、同步电机 Three-phase squirrel cage asynchronous and synchronous motors
交流电压 AC voltage	3000---10000VAC
工作频率 Service frequency	50HZ/60HZ±2HZ
相序 Phase sequence	SEC-SPHMV 允许在任何相序下工作(可通过参数设定) SEC-SPHMV is allowed to work with any phase sequence (through setting)
主回路组成 Composition of major	(12SCRS、18SCRS、30SCRS 视型号而定) (12SCRS、18SCRS、30SCRS depend on model)
旁路接触器 Bypass contactor	具有直接起动容量的接触器 Contactor with direct starting capacity
控制电源 Control power	AC220V±15%
瞬时过电压保护 Transient voltage overload	dv/dt 吸收网络 dv/dt snubber network
起动频次 Start frequency	1—6 次(每小时) 1-6 time per hour
环境条件 Ambient condition	环境温度: -20°C +50°C Ambient temperature: -20°C +50°C
	相对湿度: 5%---95%无凝露 Relative humidity: 5%---95% no condensation
	海拔小于 1500 米(大于 1500 米需降容使用)
	Altitude less than 1500m(derating when altitude is more than 1500m)
保护功能 Protective functions	
缺相保护 Open-phase protection	在起动或运行过程中, 断开主电源的任意相 Cut off any phase of primary power supply in the courage of starting or operation
运行过流保护 Over-current protection in	运行过流保护设定: 20~500%Ie Operational Over-current protection setting:20~500%Ie
相电流不平衡保护 Unbalanced phase current	相电流不平衡保护: 0~100% Unbalanced phase current protection:0~100%
过载保护 Overload protection	过载保护级别: 10A、10、15、20、25、30 Overload protection grade:10A、10、15、20、25、30
欠载保护 Under load protection	欠载保护级别: 0~99% 欠载保护动作时间: 0~250S Under load protection grade:0~99% Action time of under load protection: 0~250S
起动超时 start timeout	起动时间限制: 0~120S Start timeout limit:0~120S

过压保护 Over-voltage protection	主电源电压高于额定值的 120%时, 过压保护 When voltage of primary power supply is 120% higher than rated value, over-voltage protection is enabled.
欠压保护 Under-voltage protection	主电源电压低于额定值的 70%时, 欠压保护 When voltage of primary power supply is 70% higher than rated value, over-voltage protection is enabled.
相序保护 Phase protection	允许在任何相序下工作(可通过参数设定) Allow to work with any phase sequence(through setting parameter)
接地保护 Ground protection	接地电流大于设定值时保护 Protection available when grounding current is higher than set value
通讯说明 <i>Description of communication</i>	
通讯协议 Protocol	Modbus RTU
通讯接口 Communication interface	RS485
网络连接 Network connection	每台 SPH MV 可与 32 台 SPH MV 设备连网通讯 Each SEC-SPH MV can communicate with 32 SEC-SPH MV equipment in
功 能 Function	通过通讯接口可以观察运行状态、编程 Operation state and programming can be observed through communication interface
操作界面 <i>Operating interface</i>	
LCD 显示 LCD display	LCD(液晶)显示/触摸屏显示 LCD display/touch screen display
语 言 Language	中、英文 Chinese and English
键 盘 Keyboard	6 个触摸式薄膜按键 6 touch membrane keyboard
仪表显示 <i>Meter display</i>	
主电源电压 Voltage primary power supply	显示三相主电源电压 Display voltage of three-phase primary power supply
三相电流 Three-phase current	显示三相主回路电流 Display current of three-phase major loop
数据记录 <i>Date record</i>	
故障记录 Fault history	记录最近 15 次故障信息 Record recent 15 faults information
起动次数记录 History of number of starts	记录本装置的起动次数 Record number of starts of this soft starter

1.3 一次方案(Diagram of major loop)

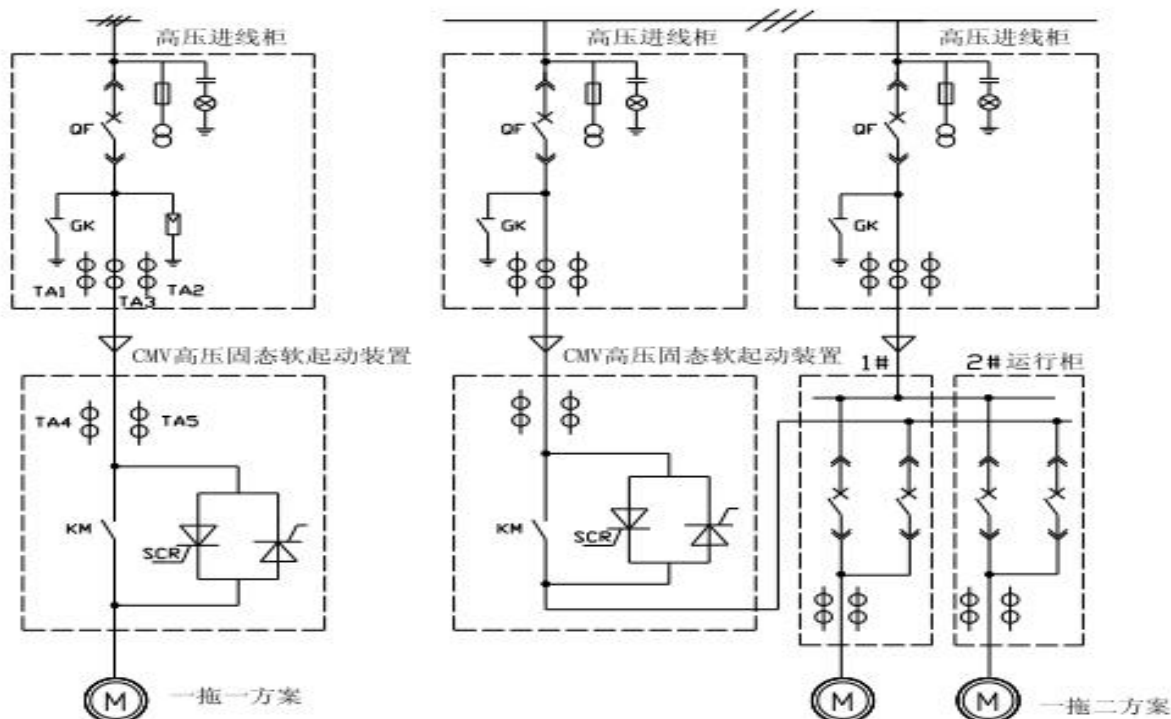

1.4 设计结构 (Design structure)

完整的 SEC-SPHMV 系列软起动装置是一个标准的电机起动、保护装置，用来控制和保护高压交流电机。标准的 SEC-SPHMV 产品主要由以下部件组成：高压可控硅模块、可控硅保护部件、光纤触发部件、真空开关部件、信号采集与保护部件、系统控制与显示部件。

Complete SEC-SPHMV series soft is a standard device for starting and protecting motors, and can be used to control and protect high voltage AC motors. Standard SEC-SPHMV product is composed of the following parts: high voltage thyristor module, thyristor-protecting parts, optical fiber triggering parts, vacuum switch parts, signal acquiring and protecting parts, system controlling and display parts.

- ◆ **可控硅模块：**每相中采用相同参数的可控硅串并联安装在一起。根据所使用电网的峰值电压要求，选择可控硅串联的数量不同。
- ◆ **Thyristor module:** the thyristor of the same parameters are assembled in series-parallel in each phase. the number of the selected thyristor to be assembled in series is different, which depends on the peak voltage requirement of the grid used.
- ◆ **控硅保护部件：**主要包括由 RC 网络组成的过电压吸收网络、由均压单元组成的均压保护网络。
- ◆ **Thyristor-protection parts:** mainly include over-voltage snubber network composed of RC network and the voltage balance protecting network composed of voltage balancing units.
- ◆ **光纤触发部件：**采用强触发脉冲电路，保证触发的一致性和可靠性；利用光纤触发进行可靠高低压隔离。

- ◆ **Optical fiber trigger parts:** the consistency and reliability of the triggering are ensured by strong triggering pulse circuit ;optical fiber trigger is used for reliable separation of high voltage and low voltage.
- ◆ **真空开关部件:** 在起动完成后，三相真空旁路接触器自动吸合，电动机投入电网运行。
- ◆ **Vacuum switch parts:** at the starting is completed, three-phase, vacuum bypass contactor closes automatically, and the motor is put into grid for operation.
- ◆ **信号采集与保护部件:** 通过电压互感器、电流互感器、避雷器、零序电流互感器对主回路电压、电流信号进行采集，主 CPU 控制并进行相应保护。
- ◆ **Signal acquisition and protecting parts:** the acquisition of the voltage and current signals in the major loop, control of main CPU and corresponding protection are realized by voltage transformer,current transformer,arrester and zero sequence current transformer.
- ◆ **系统控制与显示部件:** 32 位 ARM 核微控制器执行中心控制、LCD 液晶\触摸屏显示，可显示三相电压、电流，故障信息、运行状态等。
- ◆ **System controlling and displaying parts:** 32-bit ARM-core microcontroller performs the central control. LED/touch display can display three-phase voltage,current,fault information and running state etc..

1.5 总体结构 (*General structure*)

SEC-SPHMV 系列总体结构精心考虑以适应各种使用对象和工作环境。

The general structure of the SEC-SPHMV series incorporates careful consideration with the purpose of meeting the requirement of various application objects and working environments.

- ◆ **结构:** 结构采用 GB11022-1999-T 高压开关设备和控制设备的共用技术要求，在柜体中应用密封处理，减少对机器内部的污染，布局合理。先进的数字触发系统将低压控制通过光纤连接到高压部分，便捷的维修设计允许各相模块可以迅速单独进行更换。为运行安全起见，高压部分和低压部分完全隔离开来。
- ◆ **Structure:** the structure meets the common technical requirement of GB11022-1999-T high voltage switchgear and control equipment. Sealing is adopted in the cabinet to reduce the pollution to the inside of the machine with reasonable layout, The advanced digital triggering system connect the low control to the high voltage part through optical fiber, and the convenient maintenance design allows the modules of different phase to be replaced quickly and separately. To ensure the running safety, high voltage part shall be separated from the low part completely.
- ◆ **区域:** SEC-SPHMV 整体结构被划分为 3 个相互绝缘的部分。由高压可控硅模块、可控硅保护部件、真空开关 部件等组成的高压回路；由光纤触发部件、信号采集与保护部件组成的可控硅触发及信号采集与系统保护 单元；由系统控制与显示部件构成的系统控制和人机交互单元；3 个单元之间相互绝缘，做到高、低压之间的可靠隔离。
- ◆ **Parts:** The general structure of SEC - SPHMV is divided into three parts with mutual isolation, including the high voltage loop composed of high voltage thyristor module, thyristor-protecting

parts, vacuum switch parts ect.. the thyristor triggering and signal acquiring and system protecting unit composed of optical triggering parts, signal acquiring and protecting parts; and the system controlling and human-computer interacting unit composed of system controlling and displaying parts. The three units shall be isolated from each other, and the reliable isolation of high voltage from low shall be achieved.

电源电缆可以从机柜的顶部或底部位置进入，在柜体内留有足够的空间以便于接电源进线、电机电缆从机柜的底部位置进入允许适当地进行弯曲。

The power cable can enter the cabinet from the top or bottom. There shall be enough space in the cabinet to facilitate the connection of the incoming line of power supply. The cable of the motor can be bent in a proper way when entering the cabinet from the bottom.

- ◆ **接地线：**为保障 SEC-SPHMV 的可靠运行，机柜中各个控制单元地线相连接至机柜的下部接地铜排上。
- ◆ **Earth line:** To ensure the reliable running of SEC-SPHMV, the earth wires of the control units in the cabinet shall be connected to the earthing copper bar at the lower part of the cabinet.
- ◆ **运输规定：**机柜上开孔和弯角可以承受和支持整个机柜结构的最大重量。
- ◆ **Transportation provisions:** The openings and the bent corners on the cabinet can bear and support the max weight of the whole cabinet structure.

1.6 工作原理 (Operating Principles)

SEC-SPHMV 系列的控制核心是微处理器 CPU。微处理器对 SCR 进行相角触发控制以降低加在电机上的电压，然后通过慢慢地控制加在电机上的电压和电流平滑地增加电机转矩，直到电机加速到全速运行。这种起动方式可以降低电机的起动冲击电流，减少对电网和电机自身的冲击。同时也减少了对连在电机上机械负载装置的机械冲击，以延长设备的使用寿命，减少故障和停机检测时间。

The control core of the SEC-SPHMV series is the microprocessor CPU. The microprocessor controls phase-angle triggering of SCR to reduce the voltage on motor, and then control the voltage and current on the motor slowly and increase the motor torque smoothly, until the motor steps up to full-speed running. Such starting method can reduce the impulse current during the starting of motor and the impact to grid and the motor itself, and also reduce the mechanical impact on the mechanical loading devices attached to the motor, so as to prolong the service life of the equipment and reduce faults and stop detection time.

当电机达到全速运行后，电机电流降到正常全速运行的电流值，SEC-SPHMV 系列软起动装置有一个旁路输出继电器，从而使旁路高压真空接触器闭合，使电机电流经旁路接触器，防止 SCR 导通所产生的压降引起的热损耗，提高了工作效率及可靠性。如图(1)所示。

In the state of full-speed running the current of the motor falls to the current value at normal full-speed running. SEC-SPHMV series soft starter has a bypass output relay, which can make the bypass high voltage vacuum contact closed and make the current of the motor pass through the contactor, so as to prevent the heat loss arising from the voltage drop caused by the on-state of SCR, and improve the operating efficiency and reliability, as shown in figure(1).



图 (1) Figure(1)

1.7 技术特点 (Technical characteristics)

- ◆ **免维护:** 可控硅是无触点的电子器件, 不同于其他类型的产品需经常维护液体和部件等, 把机械寿命变为电子元件使用寿命, 连续运行数年也无需停机维护。
- ◆ **Free maintenance:** Thyristor is an electric devices without contacts. Different from other kinds of products than need frequent maintenance on liquid and parts, etc., it turns the mechanical life into the service life of the electronic components, so it needs no maintenance after running for many years.
- ◆ **安装使用简单:** SEC-SPHMV 是一个完整的电机动控制和保护系统, 安装时只需连接电源线和电机线即可投入运行, 在加高压运行前, 允许使用低压对整个系统进行电气测试。
- ◆ **Easy installation and operation:** SEC-SPHMV is a complete system for controlling and protecting the starting of motor. It can put into operation only with the power line and motor line connected. The whole system can be tested electrically under low voltage before operating with high voltage.
- ◆ **备份特性:** 装置内部装有可直接起动电机的真空接触器, 如果 SEC-SPHMV 出现故障, 可利用真空接触器直接起动电机, 以保证生产的连续性。
- ◆ **Backup:** The starter comes equipped with a vacuum contactor which can be used to start the motor directly in the inside. If SEC-SPHMV fails, the vacuum contactor can be used to start the motor directly to ensure the continuity of production.
- ◆ 以高压晶闸管为主回路部件, 并具有均压保护和过电压保护系统。
- ◆ High voltage thyristor is a components of major loop, equipped with voltage balancing protection system and over-voltage protection system.
- ◆ SEC-SPHMV 安装电磁闭锁装置, 防止在带电情况下误入高压装置内。

- ◆ SEC - SPH MV comes equipped with an electromagnetic blocking device for fear of entering the high voltage device in the electrified state.
- ◆ 先进的光纤传输技术，实现高压晶闸管的触发检测与低压控制回路之间的隔离。
- ◆ Advanced optical fiber transmission technology realizes the triggering detection of high voltage thyristor and the isolation between the low control loop.
- ◆ 采用 32 位 ARM 核微控制器执行中心控制，控制实时高效、显示直观、可靠性高、稳定性好。
- ◆ 32-bit ARM-core microcontroller is used to perform central control which is real-time and high efficient with visible display, high reliability and excellent stability.
- ◆ 中/英文液晶\触摸屏显示系统，操作界面人性化。
- ◆ LCD/touch screen display system in both Chinese and English with human-friendly operating interface .
- ◆ 具有 RS-485 通讯接口，可与上位机或集中控制中心进行通信。
- ◆ RS - 485 communication port can be used to communicate with the upper computer or centralized control center.
- ◆ 所有电路板均经过严格的老化实验。
- ◆ Aging experiments are made on all circuit boards .

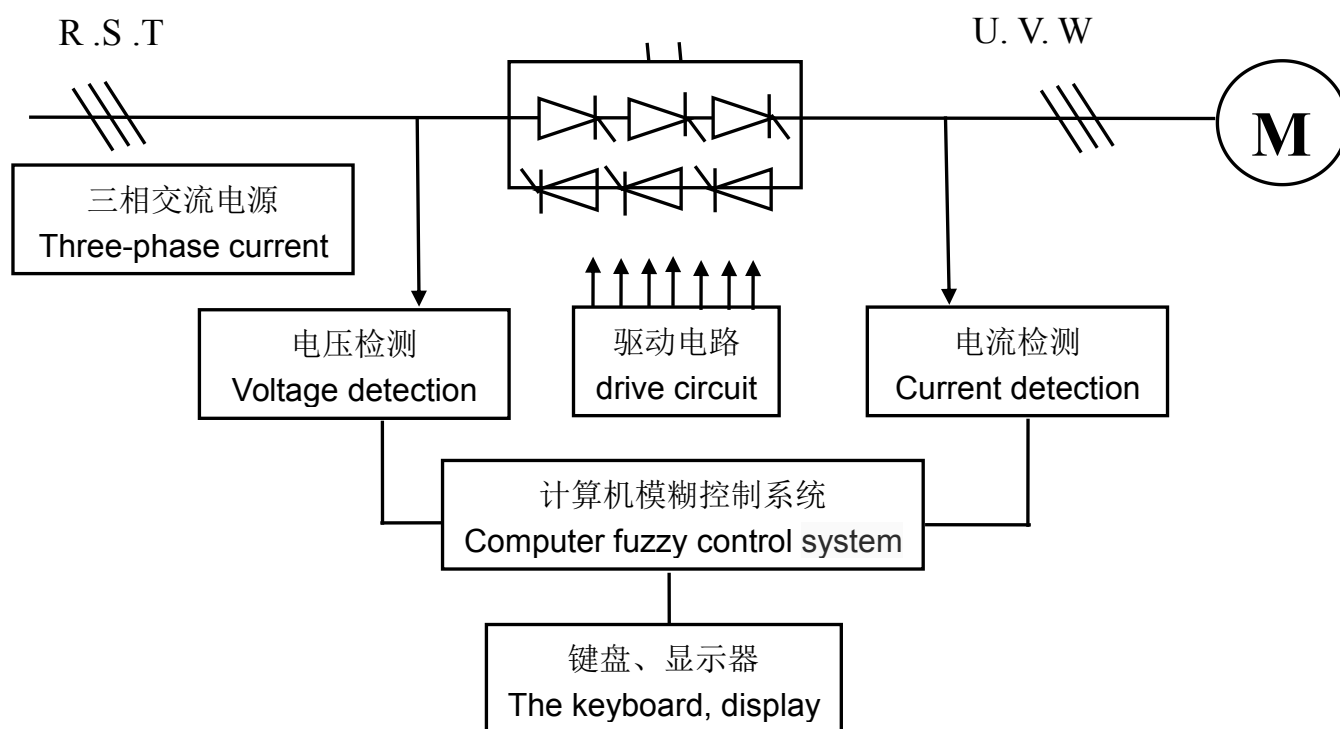
第二章 操作说明

Section 2 Operating Instructions

2.1 面板说明 (*Panel introduction*)

本装置面板有以下几原件组成:

The device panel is composed of following elements:

- | | |
|-------------|-----------------------------------|
| a) LCD 人机界面 | a) LCD man-machine interface |
| b) 带电显示装置 | b) Live display device |
| c) 数显高压表 | c) Digital display voltage meter |
| d) 数显电流表 | d) Digital display current meter |
| e) 运行指示灯 | e) Operation indicator |
| f) 停止指示灯 | f) Stop indicator |
| g) 故障指示灯 | g) Fault indicator |
| h) 起动按钮 | h) Start-up button |
| i) 停止按钮 | i) Stop button |
| j) 急停按钮 | j) Emergency stop button |
| k) 转换开关 | k) Switcher |
| l) 电磁闭锁装置 | l) Electromagnetic locking device |

2.2 工作原理及操作流程 (*Operating principle and process*)

2.2.1 接线及检查 (*Wiring and check*)

- (1) 接线前, 请保证所有开关处于断开位置。

Please ensure that all switches are in off state before wiring.

- (2) 请按照中高压柜相关标准对软启动柜进行安装。

Install the soft start cabinet according to relevant standards of medium and high voltage cabinet.

- (3) 主回路连接: 端子 R-S-T 连接电源端。

端子 U-VW 连接电机端。

Major loop connection: Terminal R-S-T connects to power source.

Terminal U-VW connects to motor.

- (4) 控制端子连接: 由用户提供 AC220V/50HZ, 接至低压仓用户端子的相应位置上。

Control terminal connection: the power AC220V/50HZ provided by clients connects to the corresponding position of client terminal in low voltage chamber.

- (5) 接地: 将接地电缆接在柜体的地排 (GND) 上。

Earthing :Connect the grounding cable to GND of the cabinet.

请检查主回路电压和控制回路电压是否与软起动装置的电压等级匹配。

Check whether the major loop voltage and control loop voltage match the voltage of the soft starter.

软起动装置将部分信号预留在外控接线端子上，用户可根据需要接线。

The soft starter reserves part of signals on external wiring terminal and user may conduct wiring as needed.

2.2.2 送电及操作 (*Power on and operation*)

(1) 将控制电源 (AC220V) 微型断路器装置于闭合位置，此时软起动面板上的 LCD 人机界面显示 “STOP”、停止指示灯点亮 (绿色)、三相数显电压/电流分布被点亮。

When the micro circuit breaker of AC220V control power is placed at closed position, the LCD man-machine interface on the panel of the soft starter indicates “stop”, stop indicator (green) is lighted up and digital display voltage/current meters are lighted up respectively.

(2) 将上端主电源断路器置于闭合位置，此时软起动面板上的带电显示器发光二极管被点亮 (表示三相主电源带电)，数显电压表显示三相主电源电压。

When the upper primary power switch is placed at closed position, the LED of live display on the panel of the soft starter is lighted up indicating that three-phase power supply is switched on and digital display voltage meter displays the voltage of three-phase power supply.

(3) 在待机情况下，浏览软起动装置内部设置参数，确保参数设置与实际负载相匹配。

In standby, Browse internal set parameters of the soft starter to ensure that parameter setting matches the actual load.

(4) 请确保当前三相电源正常的情况下，方可进行操作。

Please ensure that operating work is done when the current three-phase power supply is normal.

2.2.3 控制方式 (*Control mode*)

(1) 本装置具有本控/远控/DCS 控制三种起停控制方式，用户可通过面板上的转换开关进行转换 (禁止在装置运行过程中切换)。

This device has three control modes including local, remote and DCS control. Users can change the control mode via the switcher on the panel (forbidden to change the control mode during the operation of the device).

(2) 本装置启动控制分为 “软起/直起” 两种方式

The startup control of this device has soft start and direct start.

软起方式：将“软起/直起”钥匙开关选择“软起”位置，按起动按钮（绿色），电机开始启动。用户可通过本装置上的三相数显电流表，观察电机启动过程及运行过程中的电流。电机启动完成后，自动切换到旁路运行状态，装置上的运行指示灯被点亮（红色）。

Soft start mode: Turn the switcher to the position of “soft start” and press the startup button(green) to start the motor. Users can observe the starting course of the motor and the current via digital three-phase ampere meter mounted on the device. After the startup fo the motor, it automatically switches to bypass state and the operation indication indicating lamp on the device is lighted up(red).

启动或运行过程中接下面板上的红色停止按钮，则电机停机且面板停止指示灯亮（绿色）。

Press the red stop button on the panel in the process of startup and operation, the motor will stop and indicator lamp on panel will be lightened up (green).

当装置检测到故障后，面板上的故障指示灯（黄色）亮，且电机自动停止运行。

When a fault is detected in the soft starter, the fault indicator lamp(yellow) on hte panel will be lighted up and the motor will stop automatically.

故障必须被清楚后才能进行下一次操作（用户可通过切断外部控制 AC220V 电源的方式清除面板上的故障显示）。

The next operation shall not be allowed until fault is removed (users can remove the fault display on the panel by cutting off the external AC220V power supply).

直起方式：将“软起/直起”钥匙开关选择“直起”位置，按起动按钮（绿色），真空接触器吸合。用户可通过本装置上的三相数显电流表，观察电机启动过程及运行过程中的电流。电机通过真空接触器直接运行，运行指示灯被亮（红色）。

Direct start mode: Turn the switcher to the position of “direct start”, press the startup button(green) and the vacuum contactor suck up. Users can observe the starting course of the motor and the current via digital three-phase ampere meter mounted on the device. The motor operates directly through the vacuum contactor and the operation indicating lamp on the device is lightened up(red).

启动或运行过程中按下面板上的红色停止按钮，则电机停机且面板停止指示灯亮（绿色）。

Press the red stop button on the panel in the process of startup and operation, the motor will stop and indicator lamp on panel with be lightened up(green).

当装置检测到故障后，面板上的故障指示灯（黄色）亮，且电机自动停止运行。

When a fault is detected in the soft starter, the fault indicator lamp(yellow) on the panel will be lighted up and the motor will stop automatically.

故障必须被清除后才能进行下一次操作（用户可通过切断外部控制 AC220V 电源的方式清除面板上的故障显示）。

The next operation shall not be allowed until fault is removed(users can remove the fault display on the panel by cutting off the external AC220V power supply).

起动或运行过程中发生紧急情况，可通过装置面板上的急停按钮紧急停车。

In case of emergency occurs in the process of starting and operation, please press the emergency button on the panel of the soft starter for emergency stop.

本装置出厂时，默认为本地控制、软起模式与断路器柜连锁信号处于闭合位置。

The device is defaulted as local control, soft starting mode and the interlocking signal of switch cabinet is at closed position when it is delivered.

若高压固态软起动装置为一拖多的情况，则参照上述操作方法进行操作，当一台电机起动完成后，间隔时间必须大于 10 分钟后，方可起动第二台电机。

If the high voltage solid soft starter is one for multiple, please operate the device according to the method mentioned above. The second motor should be started with the interval greater than 10 minutes after the first motor starts.

第三章 安装

Section 3 Installation

3.1 产品规格及外形尺寸 (Specification and dimension)

电压等级 Voltage Grade	规格型号 Specification	额定电流(A) Rated Current(A)	宽 (mm) W (mm)	高 (mm) H (mm)	深 (mm) L (mm)
3000V	SEC-SPHMV-400-3	100	1000	2300	1500
	SEC-SPHMV-630-3	150			
	SEC-SPHMV-1600-3	400	1300	2300	1600
	SEC-SPHMV-2500-3	≥600	预定 Reserved		
6000V	SEC-SPHMV-420-6	50	1000	2300	1500
	SEC-SPHMV-630-6	75			
	SEC-SPHMV-1250-6	150			
	SEC-SPHMV-1600-6	200	1300	2300	1600
	SEC-SPHMV-2500-6	300			
	SEC-SPHMV-3300-6	400			
	SEC-SPHMV-4150-6	500			
SEC-SPHMV-5000-6	≥600	预定 Reserved			
10000V	SEC-SPHMV-420-10	30	1000	2300	1500
	SEC-SPHMV-630-10	45			
	SEC-SPHMV-800-10	60			
	SEC-SPHMV-1250-10	90			
	SEC-SPHMV-1500-10	110			
	SEC-SPHMV-1800-10	130			
	SEC-SPHMV-2250-10	160			
	SEC-SPHMV-2500-10	180			
	SEC-SPHMV-2800-10	200	1300	2300	1600
	SEC-SPHMV-3500-10	250			
	SEC-SPHMV-4000-10	280			
	SEC-SPHMV-4500-10	320			
	SEC-SPHMV-5500-10	400			
	SEC-SPHMV-6000-10	430			
SEC-SPHMV-7000-10	500	预定 Reserved			
SEC-SPHMV-8500-10	≥600	预定 Reserved			

✧ 以上是典型产品型号，如果您所需型号不在此表中，请与厂方联系。

- ◇ The above models are typical product models. If the models you require are not included in the table, please contact the manufacturer.
- ◇ 注意：以上机柜尺寸仅供参考，需要精确尺寸请与厂方联系。
- ◇ Notice: The above dimensions are just for reference. If you need precise dimensions, please contact the manufacturer.
- ◇ 网侧接触器为可选件，如需增加网侧接触器，请在订货时说明。
- ◇ Net-side contactor is optional. If you want net-side contactor , please specify it in the order.

3.2 接收和开箱 (*Acceptance and unpacking*)

每台 SEC-SPHMV 软起动装置在出厂前均进行了全部功能与运行测试，用户在收到设备并拆封后，请按下列步骤检查。如发现问题，请立即与用货商联系。

Test of all the functions and running tests are made on every SEC-SPHMV soft starter before delivery. After receiving and unsealing the starter, please check according to the following steps. If problems are found. Please contact the supplier immediately.

- ◆ 确认所收到产品型号与所订购的产品型号一致，产品型号在产品铭牌上。

Confirm that the product models you receive are the same as that you ordered. Product model is shown on the nameplate.

- ◆ 检查是否随机配备产品合格证、出厂检验报告、保修卡、产品说明书、接线图纸等。

Check whether the product is equipped with certificater of qualification, delivery inspection report, warranty card, product description and wiring diagram.

- ◆ 观察是否在运输和搬运过程中有损坏。

Observe whether the product is damaged during transport and handling.

- ◆ 检查是否运输和搬运过程中有机械部件松动或断线现象，接线松动会增加阻抗影响功能。

Check whether the mechanical parts become loose and whether the line is broken during transport and handling . Loose wiring will increase the impedance and interfere with functions of the product.

3.3 安装 (*Installation*)

- ◆ 软起动装置必须垂直安装。

The soft starter must be installed vertically.

- ◆ 切勿将软起动装置安装在热源处。

Never install the soft starter at the place of heat source.

- ◆ 安装前要断开所有的电源。

Disconnect all the power supplies before installation.

- ◆ 安装要遵循当地的电器规章和标准，要符合 IEEE 标准。

The installation shall be in compliance with the local regulations and standards of electric apparatus as well as IEEE standard.

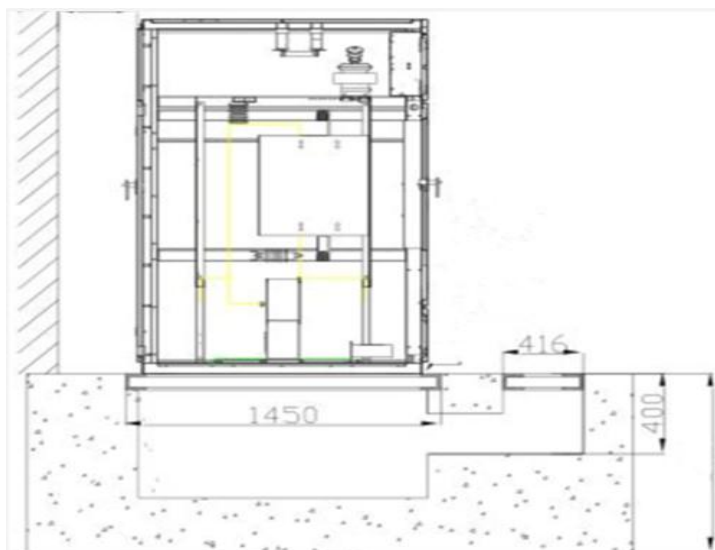

高压固态软起动装置基础图

High Voltage Solid Soft Starter installation foundation

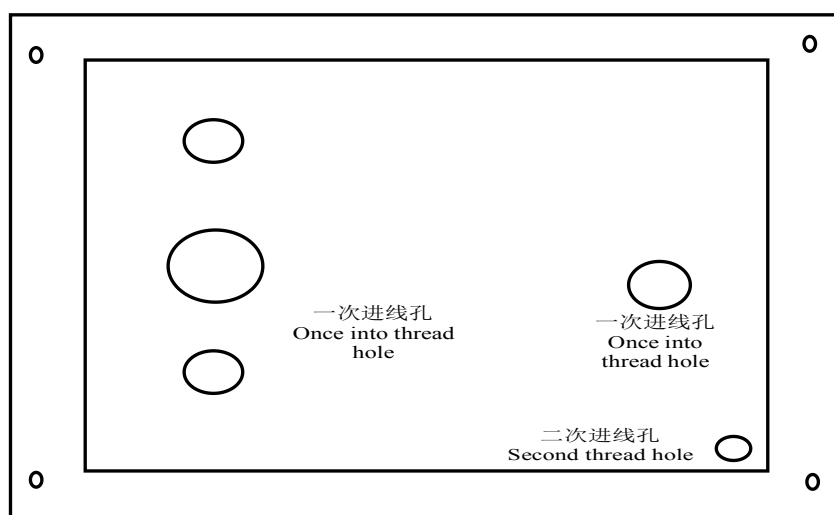

高压固态软起动装置底部视图

High Voltage Solid Soft Starter bottom view

3.4 设备附加改造 (Additional reconstruction of the equipment)

如果进入机柜的连线因位置不合适需要在机柜上另外打孔，要遮盖住机内的电器部件等机构，严防金属屑留在机内，以免引起严重的短路事故。在钻孔完毕后要仔细的清理机内，并检查工作区内是否有其它损坏。

If the connection of wire that come into the cabinet require additional holes due to improper positions, the electric parts in the cabinet shall be covered to prevent the metal filings from straying in the machine and resulting in serious accident of short circuit. Clean the inside of the cabinet carefully after drilling the hole, and check whether there are damages in the working area.

第四章 LCD 显示器的操作

Section 4 Operation of LCD Display

4.1 按键功能说明 (Functional description of keys)

符号 Signs	名称 Item	功能说明 Functional Description
⊖	确认键 Enter Key	进入参数菜单，确认需要修改数据的参数项 Enter the parameter menu, and confirm the date of parameter items to be altered
⬆	递增键 Increase Key	参数项或数据的递增 Increase parameter items or data
⬇	递减键 Decrease Key	参数项或数据的递减 Decrease parameter items or data
Ⓜ	退出键 ESC Key	确认修改的参数数据并退出参数项，退出参数菜单 Confirm the altered parameter data and escape from the parameter items and parameter menu.
Ⓜ	运行键 Run Key	键操作有效时，用于运行操作，并且端子排 X1 的 3、5 端子短接。 The key can be used for running operation when effectively operated, and at the time the terminal 3 and 5 on the terminal block X1 are short-circuited.
Ⓜ	停止键 Stop Key	键操作有效时，用于停止操作，故障状态下按停止键 4 秒以上可复位当前故障。 The key can be used for shopping operation when effectively operated.Pressing the stop key for four seconds at the state of fault can reset the current fault.

4.2 修改参数项操作流程 (Operation flow for altering parameter items)

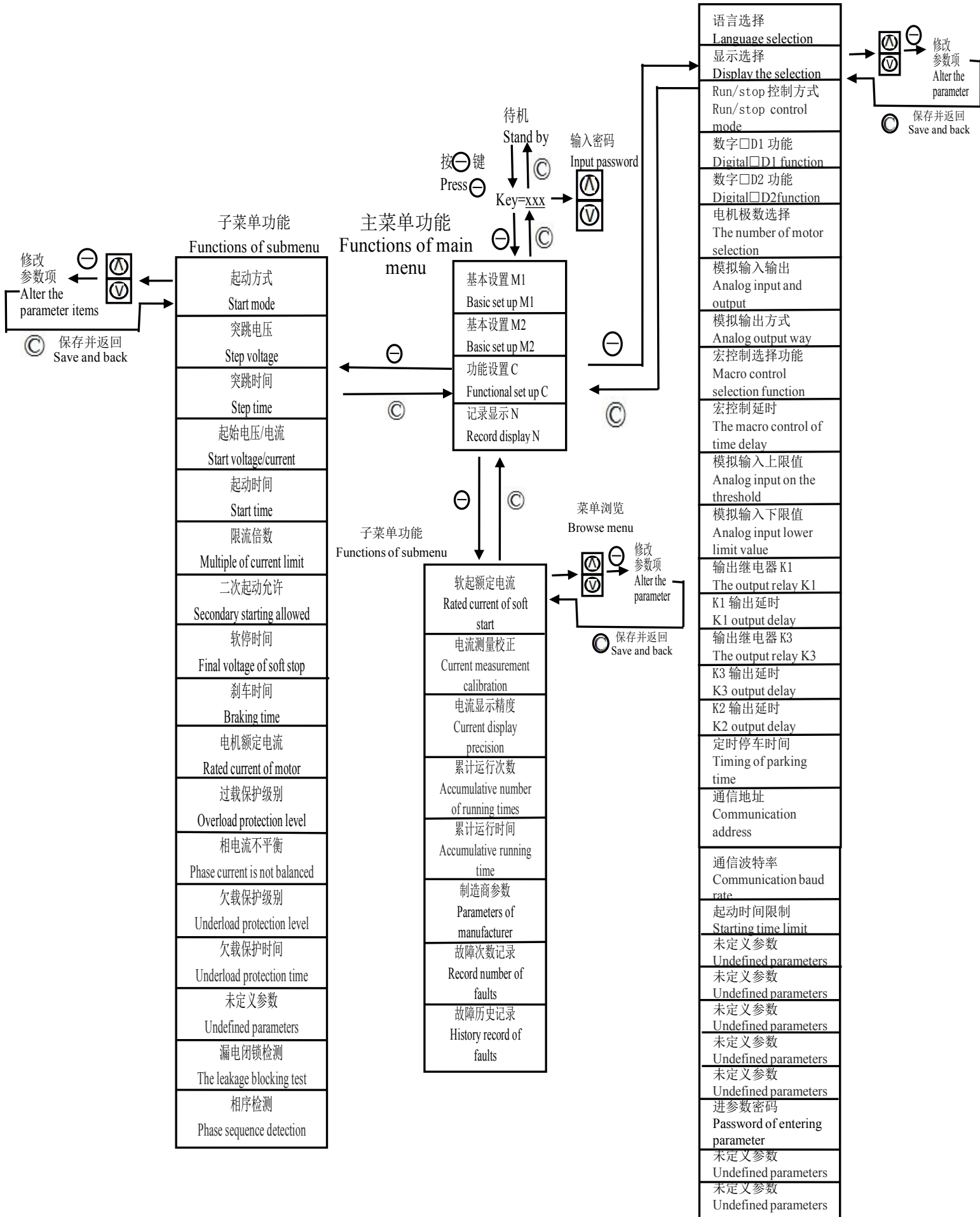

第五章 起动

Section 5 Start

警告：SEC-SPHMV 具有潜在的能伤害人身的电压，必须由经过授权和培训的人员来操作。SEC-SPHMV 安装时只需连接电源线和电机线即可投入运行，在加高压测试前，允许先使用低压(AC380V)对整个系统进行测试。

Warning: SEC-SPHMV can potentially damage the personal voltage, must by authorized and trained personnel to operate. Only when the SEC-SPHMV installation line connect the power cord and motor can be put into operation, in high voltage test before, allows to use low pressure (AC380V) to test the whole system.

5.1 低压测试步骤 (Procedures for low voltage test)

- ◆ 确认在电器部件上没有任何电压。

Ensure there is no any voltage on the electrical parts.

- ◆ 检查所有的导线是否连接良好。

Check whether all conductors are well connected.

- ◆ 连接输入电源(三相 AC380V)到软起动装置的输入接线端子(R、S、T)。

Connect the input supply (three-phase AC380V) to the the input connecting terminals (R, S, T) of the soft starter.

- ◆ 将主控板上的三相同步插头拔掉，插上低压同步测试线，线的另一端接至主回路进线端 R、S、T（在接线的时候应注意，主回路 R 与主板的 Va 相对应，S 与主板的 Vb 相对应，T 与主板的 Vc 相对应）。

Pull out the three-phase synchronous plug on the main control board, and plug in the low voltage synchronous test wire, with the other side of the test wire connected to the incoming line sides R,S and T in the major loop (during wiring, notice that R in the main loop shall correspond to Va on the main board, S to Vb and T to Vc).

- ◆ 将 AC220V 电源接在外控端子的 L、N 上。

Connect AC220V power supply to the external control terminal L and N.

- ◆ 将低压测试负载接在 SEC-SPHMV 软起动装置的 U、V、W 端。

Connect LV test load to U,V,W ends of SEC-SPHMV soft starter.

- ◆ 关闭装置内部的欠压保护功能(参见装置内部接线图)。

Close the under-voltage protection function in the starter(refer to internal wiring diagram of the starter).

- ◆ 检查所有的连线正确后，将柜内 QF 断路器闭合。

After ensure that all wirings are correct, close the QF circuit breaker in the cabinet.

- ◆ 关闭柜门，准备进行低压测试。

Close the door of the cabinet and get ready for low voltage test.

- ◆ 接通 AC380V 电源，通过操作装置面板上的起动、停止按钮，观察负载起动是否正常。

Connect with AC380V power supply, and observe whether the starting of the load is normal or not by operating the start and stop button on the panel of the starter.

- ◆ 测试完毕后将接线拆除，准备进行高压测试。

Remove the wiring after test and prepare for high voltage test.

5.2 高压测试步骤 (*Procedures for high voltage test*)

- ◆ 将 AC220V 电源接在外控端子的 L、N 上。

Connect AC220V power supply to the external control terminal L and N.

- ◆ 连接输入高压电源到软起动装置的输入接线端子(R、S、T)。

Connect the input high voltage power supply to the input connecting terminals(R,S,T) of the soft starter.

- ◆ 连接高压电机到软起动装置的输出接线端子(U、V、W)。

Connect the high voltage motor to the input connecting terminals(U、V、W) of the soft starter.

- ◆ 检查所有的连线正确后，将柜内 QF 断路器闭合。

After ensure that all wirings are correct, close the QF circuit breaker in the cabinet.

- ◆ 关闭柜门，准备进行高压测试。

Close the door of the cabinet and be ready for high voltage test.

- ◆ 检查软起动装置的设定电流是否与实际的电机额定电流相匹配。

Check whether the setting current of the soft starter matches the actual rated current of the motor.

- ◆ 检查电机的起动控制参数，如果需要可进行修正，请参见第五章编程部分的详细说明。

Check the starting control parameters of the motor, and refer to the details description in the programming part of Section 5 if the parameters need to be corrected.

- ◆ 通过操作装置面板上的起动、停止按钮，观察负载起动是否正常。

Observe whether the starting of the load is normal or not by pressing the start and stop button on the panel of the starter.

5.3 软起动控制模式 (*Control mode of soft start*)

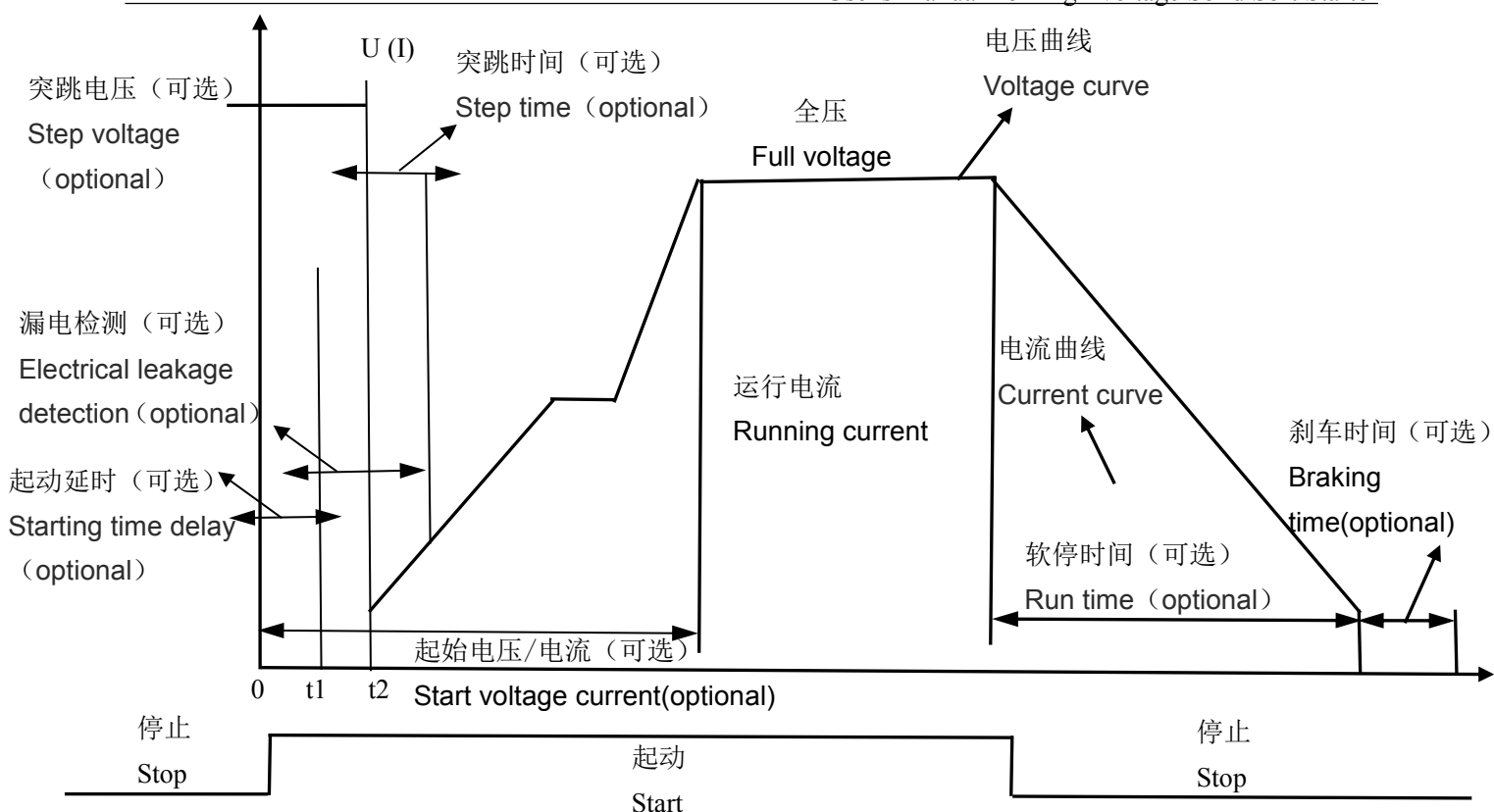

软起/软停电压（电流）特性曲线 图（2）

Characteristics Curve of Soft Start/Soft Stop Voltage (Current) Figure(2)

SEC-SPHMV 系列软起动装置有多种起动方式：限流软起动、电压线性曲线起动、电压指数曲线起动、电流线性曲线起动，电流指数曲线起动；多种停车方式：自由停车、软停车、制动刹车，软停+制动刹车，还具有点动功能。用户可根据负载不同及具体使用条件选择不同的起动方式和停车方式。

SEC - SPHMV series soft starting have many start modes: current-limiting soft start, voltage linear curve start, voltage exponential curve start, current linear curve start, voltage exponential curve start, current linear start, current exponential start; and many stopping modes: free stop, soft braking, soft stop+braking, and inching function. Users can choose different starting and stopping modes according to the load and specific service conditions.

5.3.1 限流软起动 (Current limiting soft start)

使用限流软起动模式时，斜坡时间设置为零，软起动装置得到起动指令后，其输出电压迅速增加，直至输出电流达到设定电流限幅值 I_m ，输出电流不再增大，电动机运转加速持续一段时间后电流开始下降，输出电压迅速增加，直至全压输出，起动过程完成。

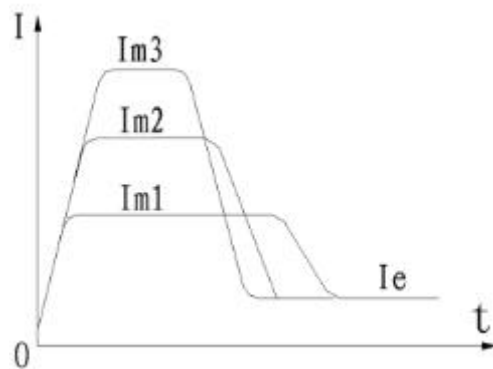

Under the mode of current limiting soft start, set the ramp time at ZERO. After the softer starter receives the starting order, its output voltage increases rapidly until the output current reaches the desired limited current amplitude value I_m , and the output current does not become large any longer, the current decreases after the motor runs and accelerates for a period of time, and the output voltage increases rapidly until the output with full voltage, and the starting process is completed.

参数 Parameter	名称 Description	范围 Range	设定值 Set value	出厂值 Value
IM04	斜坡时间 Ramp time	0~120S	0	10
IM05	限流倍数 Current limit	100~500% I_e	---	350

注：“——”表示用户自己根据需要进行设定（下同）。

Note: “——” means that customer can set according to specific application.

5.3.2 电压指数曲线 (Exponential curve voltage)

输出电压以设定的起动时间按照指数特性上升，同时输出电流以一定的速率增加，当起动电流增至限幅值 I_m 时，电流保持恒定，直至起动完成。使用此模式时，需同时设定起动时间和限流倍数。

Output voltage increases with the exponent characterizes at the desired ramp time, and at the same time, the output current increases at a certain rate. When the start current increases to the limited current amplitude value I_m , the current keeps constant until the starting is finished. In this mode, ramp time and multiple of current limit shall be set.

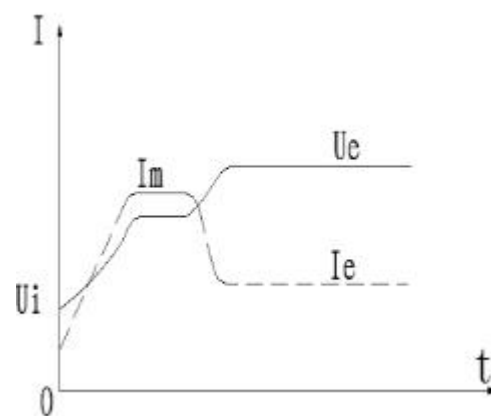

参数 Parameter	名称 Description	范围 Range	设定值 Set value	出厂值 Value
1M00	起动方式 Ramp mode of start	0~3	0	0
1M03	起始电压 Initial voltage	20~100% U_e	---	30%
1M04	斜坡时间 Ramp time	0~120s	---	10
1M05	限流倍数 Current limit	100~500% I_e	---	350

5.3.3 电压线性曲线 (Linear curve of voltage)

输出电压以设定的起动时间按照线性特性上升，同时输出电流以一定的速率增加，当起动电流增至限幅值 I_m 时，电流保持恒定，直至起动完成。

Output voltage increases with the linear characterizes at the desired ramp time, and at the same time, the output current increases at a certain rate. When the start current increases to the limited current amplitude value I_m , the current keeps constant until the starting is finished.

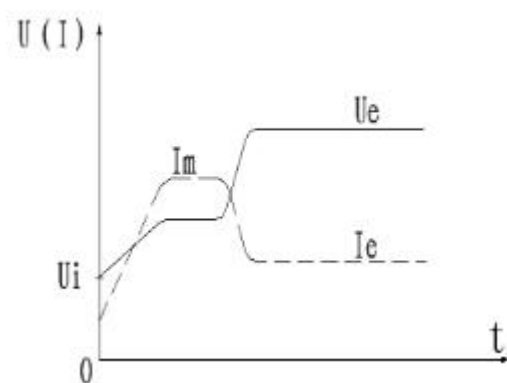

参数 Parameter	名称 Description	范围 Range	设定值 Set value	出厂值 Value
1M00	起动方式 mode of start	Ramp 0~3	1	0
1M03	起始电压 voltage	Initial 20~100%U _e	---	30%
1M04	斜坡时间 time	Ramp 0~120s	---	10
1M05	限流倍数 limit	Current 100~500%I _e	---	350

5.3.4 电流指数曲线 (Exponential curve of current)

输出电流以设定的起动时间按照指数特性上升，当起动电流增至限幅值 I_m 时，电流保持恒定，直至起动完成。使用此模式时，需同时设定起动时间和限流倍数。

Output current increases with the exponent characterizes at the desired ramp time. When the start current increases to the limited current amplitude value I_m , the current keeps constant until the starting is finished. In this mode, ramp time and multiple of current limit shall be set.

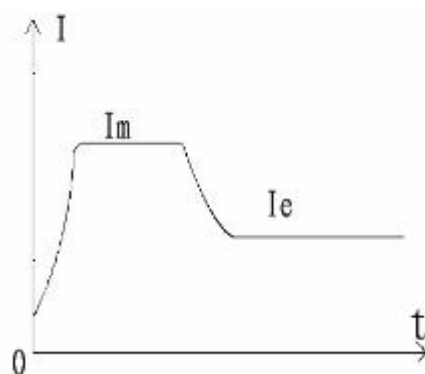

参数 Parameter	名称 Description	范围 Range	设定值 Set value	出厂值 Value
1M00	起动方式 mode of start	Ramp 0~3	0	0
1M03	起始电压 voltage	Initial 20~100%U _e	---	30%

1M04	斜坡时间 time	Ramp	0~120s	---	10
1M05	限流倍数 limit	Current	100~500%I _e	---	350

5.3.5 电流线性曲线 (Linear curve of current)

输出电流以设定的起动时间按照线性特性上升，当起动电流增至限幅值 I_m 时，电流保持恒定，直至起动完成。

Output voltage increases with the linear characterizes at the desired ramp time. When the start current increases to the limited current amplitude value I_m , the current keeps constant until the starting is finished.

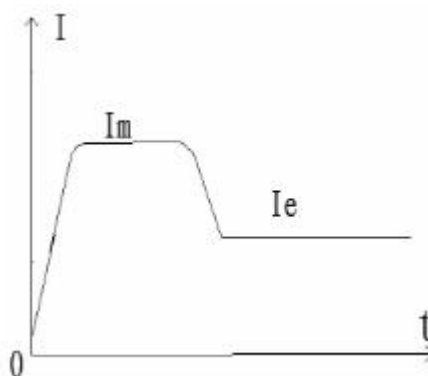

参数 Parameter	名称 Description	范围 Range	设定值 Set value	出厂值 Value
1M00	起动方式 mode of start	0~3	0	0
1M03	起始电压 voltage	20~100%U _e	---	30%
1M04	斜坡时间 time	0~120s	---	10
1M05	限流倍数 limit	100~500%I _e	---	350

5.3.6 突跳转矩软起动 (Soft start with step torque)

突跳转矩软起动模式主要应用在静态阻力比较大的负载电动机上，通过施加一个瞬时较大的起动力矩以克服大的静摩擦力矩。该模式下输出电压迅速达到设定的突跳电压，当达到预先设定的突跳时间后降为起始电压，再根据所设定的起始电压\电流、起动时间平稳起动，直至起动完成。

The soft start mode with step torque is mainly applicable for the load motor with relatively big stiction. The static friction torque can be overcome by applying a relatively large transient starting torque. Under this mode, the output voltage reaches the step voltage fast, and falls to the start voltage after the time reaches the preset step time. Stable start is then realized in accordance with the preset start voltage/current and ramp time, until the starting is finished.

参数 Parameter	名称 Description	范围 Range	设定值 Set value	出厂值 Value
1M00	起动方式 mode of start	0~3	0	0
1M03	起始电压 voltage	20~100%U _e	---	30%
1M04	斜坡时间 time	0~120s	---	10
1M05	限流倍数 limit	100~500%I _e	---	350

1M03	起始电压/电流 Initial voltage	20~100%Ue/ 20~100%Ue	---	30
1M01	突跳电压 Voltage for kick start	20~100%Ue	---	20
1M01	突跳时间 Duration of kick start	0~200mS	---	0



使用突跳转矩起动模式时必须与其它软起方式配合使用,而且要设置突跳电压和突跳时间。

When using step torque start mode, it should be supported with other soft start modes and the step voltage and time are required.

5.3.7 自由停车 (Free stop)

当软停车时间(1M07)和刹车时间(1M09)同时设置为零时为自由停车模式,软起动装置接到停机指令后,首先封锁旁路接触器的控制继电器并随即封锁主电路晶闸管的输出,电动机依负载惯性自由停机。

Free stop mode refers to the mode with soft stop time(1M7) and braking time(1M9) set at zero at the same time. After receiving the stop order, the soft starter firstly locks the control relay of the bypass contactor, and subsequently locks the output of the thyristor of the main circuit, and the motor stops freely, depending on the inertia of the load.

参数 Parameter	名称 Description	范围 Range	设定值 Set value	出厂值 Value
1M07	软停时间 Ramp down time	0~120S	0	0
1M09	刹车时间 Braking time	0~250S	0	0

5.3.8 软停车 (Soft stop)

当软停车时间设定不为零时,在全压状态下停车则为软停车,在该方式下停机,软起动装置首先断开旁路接触器,软起动装置的输出电压在设定的软停车时间内逐渐降至所设定的软停终止电压值,软停车过程结束起动装置转为刹车制动状态(刹车时间不为零)或自由停止。

Soft stop refer to the stop under the state of full voltage when the soft stopping time is not set at zero. Under such mode, the soft starter will firstly cut off the bypass contactor, and the output voltage of the soft starter will decrease to the desired soft stop final voltage value gradually within the desired soft stopping time. After the soft stop is finished, the starter turns to braking state(braking time is not zero) or stops freely.

参数 Parameter	名称 Description	范围 Range	设定值 Set value	出厂值 Value
1M07	软停时间 down time Ramp	0~120S	---	0
1M08	软停终止电压 voltage of soft stop Final	20~60%U _e	---	20
1M09	刹车时间 Braking time	0~250S	0	0

5.3.9 制动刹车 (*Braking*)

当软起动装置设置了刹车时间(1M09 功能项)并且选择了刹车时间继电器输出,则当软起动装置自由停止后,刹车时间继电器输出信号在(停)刹车时间内保持有效。用该时间继电器输出信号控制外置制动单元或机械抱闸电气控制单元。

When the braking time(function item IM09) is preset and the braking time relay output is selected, after the softer starter stops freely, the output signal of the braking time relay will keep valid within the stop(braking) time. The output signals of the time relay are used to control the external braking units or electric control units with mechanical band-type braking.

参数 Parameter	名称 Description	范围 Range	设定值 Set value	出厂值 Value
1M07	软停时间 down time Ramp	0~120S	0	0
1M09	刹车时间 Braking time	0~250S	---	0
C12	继电器 K1 功能 Output signal of relay K1	0~8	4	3
C14	继电器 K3 功能 Output signal of relay K3	0~8	4	7

5.3.10 软停+制动刹车 (*Soft stop +braking*)

当软起动装置设置了软停时间,并且设置了刹车时间,软起动装置首先断开旁路接触器,软起动装置的输出电压在设定的软停车时间内逐渐降至所设定的软停终止电压值,软停车过程结束后在所定的刹车时间内刹车。

When the soft stopping time and braking time are set, the soft starter will firstly cut off the bypass contactor, and the output voltage of the soft starter will decrease to the desired soft stop final voltage value gradually within the desired soft stopping time. After the soft stop is finished, it will brake within the preset braking time.

参数 Parameter	名称 Description	范围 Range	设定值 Set value	出厂值 Value
1M07	软停时间 Ramp down time	0~120S	---	0
1M08	软停终止电压 Final voltage of soft stop	20~60%Ue	---	20
1M09	刹车时间 Braking time	0~250S	---	0
C12	继电器 K1 功能 Output signal of relay K1	0~8	4	3
C14	继电器 K3 功能 Output signal of relay K3	0~8	4	7

5.4 参数项及其说明 (*Parameters and Description*)

高压固态软起动装置功能参数项查询及设置采用滚动方式，分为一个主菜单和四个子菜单，包含了所有可设置及可查询的功能。用户可根据需要选择中/英文显示。

Customer may inquire or modify a parameter by scrolling through the main menu and four submenus which involve all parameters can be modified and setting that can inquired. Customer can choose Chinese or English as displaying language according to different condition,

5.5 软起动装置控制参数表 (*Control parameter list of soft starter*)

5.5.1 起停控制参数 (*Start/stop control parameter*)

在停止状态下功能设置有效。

All parameters should be set when in state of stand by.

参数 Parameter	名称 Item	范围 Range	出厂值 Value
1M00	起动方式 Ramp mode of start	0、电压斜坡起动指数曲线 1、电压斜坡起动线性曲线 2、电流斜坡起动指数曲线 3、电流斜坡起动线性曲线 0、Voltage ramp start exponent curve; 1、Voltage ramp start linear curve; 2、Current ramp start exponent curve; 3、Current ramp start linear curve;	0
1M01	突跳电压 Step voltage	20~100%Ue	20%

1M02	突跳时间 Step time	0~200mS	0
1M03	起始电压/电流 Initial voltage/current	(20~100%)Ue / (20~100%)Ie	30%
1M04	斜坡时间 Ramp time	0~120S	10
1M05	限流倍数 Current limit	100~500%Ie	350
1M06	二次起动允许 start allowed	Secondary 0~60S	0
1M07	软停时间 stop time	Soft 0~120S	0
1M08	软停终止电压 Final voltage of soft stop	20~60%Ue	20
1M09	刹车时间 Braking time	0~250S	0

◆ 5.5.2 启停控制参数说明 (*Specifications of start / stop control parameters*)

◆ 起停控制参数 (*Start / stop control parameters*) 1M01-----1M09(起动控制模式说明见第 5.3 节) (*Refer to section 5.3 for start control modes*)

用户可通过参数 1M00 进行起动曲线的选择, 使得起动曲线与实际负载很好配合, 以达到最佳的起动效果。如果设置了突跳电压和突跳时间, 在起动开始时将首先施加一个瞬时较大的起动力矩, 然后按照所设定的起始电压\电流, 起动时间进行起动。如果设置了二次起动时间, 在达到二次起动所设置的时间后如果还没有起动完成, 将会按照所设定的起始电压\起始电流, 起动时间进行二次起动。在起动过程中, 起动电流被限制在参数 1M05 所设置的值以下。当 1M05 设定为 500%时, 起动过程中的起动电流将不受限制。

Users can select that start curve by parameter 1M00 to make the start curve fit in well with the practical load and achieve the optimal start effect. If the step voltage and step time are set, the starter will apply a relative large transient starting torque at the beginning of starting. And then perform the start according to the preset start voltage/current and ramp time. If secondary start time is set, in the case that the start is still unfinished after the time reaches the preset secondary ramp time, the secondary start will be carried out in accordance with the preset start voltage/start current and ramp time. In the process of starting, the start current is limited below the value set by means of the parameter 1M05. When 1M05 is set at 50%, the start current not be limited in the process of starting.

注：当起动方式选择为电压斜坡起动时，参数 1M03 代表起始电压；当起动方式选择为电流斜坡起动 14 时，参数 1M03 代表起始电流。起动过程中如果有停止命令，则停止只能是自由停车；起动完成后如果有停止命令，则停止可以是自由停车、软停车、制动刹车。

Notice: When the voltage ramp start is selected as the starting mode, the parameter 1M03 represents start voltage; while when the current ramp start is selected as the starting mode, the parameter 1M03 represents start current. If the stop order is issued in the process of starting. The stop can only be free stop; if the stop order is issued after the starting is finished, the stop can be free stop, soft stop or braking.

参数 1M04 起动时间的长短可决定在什么时间内将起动转矩升高到最终转矩。当起动时间较长时，就会在电机起动过程中产生较小的加速转矩。这样就可实现较长时间的电机软加速，应适当选择起动时间的长短，使电机能够进行软加速，一直到达其额定转速为止。当加速时间在完成电机加速之前结束时，就会在一定的时间内将转矩限制到所设置的极限转矩。因此，这里的起动时间表示了转速变化的速率，并不完全等同于电机的起动时间。

The parameter 1M04 length of ramp time can decide when the starting torque can be increased to the final torque. If the ramp time is relatively long, a relatively small accelerating torque will be produced during the starting of the motor. In such way, long-time soft acceleration of motor can be realized, The length of ramp time shall be selected properly, so as to make the motor able to carry out soft acceleration until the rated speed is attained. In the case that the accelerating time finishes before the acceleration of the motor is finished, the torque will be limited to the preset torque limit within a certain period of time. Therefore, the ramp time here represents the rate at which the speed change, and does not completely equal to the start time of the motor.

◆ 5.5.3 保护参数 (Protection parameters)

参数 Parameter	名称 Item	范围 Range	出厂值 Value
1M10	电机额定电流 motor current Rated	15.0~9999	---
1M11	过载保护级别 protection grade Overload	10A、10、15、20、25、30	20
1M12	相电流不平衡保护 Unbalanced phase current protection	0~100%	70%
1M13	运行过流保护设定 protection setting in operation Over-current	20~500%Ie	200%
1M14	欠载保护级别 protection grade Underload	0~99%	0
1M15	欠载保护动作时间	0~250S	10

	Action time of underload protection			
1M16	未定义参数 parameter	Undefined	---	---
1M17	漏电闭锁检测 leakage locking detection	Electrical	0、禁止 0、Disable	1、允许 1、Enable
1M18	相序检测 Phase sequence detection		0、禁止 0、Disable	1、允许 1、Enable

5.5.4 保护参数说明 (Specifications of protection parameters)

◆ 保护参数 (Protection parameters) 1M10-18

用户可以根据所带电机功率的大小设定 1M10 电机的额定电流，使得软起动装置与电机很好地匹配能很完善地对电机进行保护。运行过程中的电流超过了参数 1M13 所设定的过流保护值，软起动装置将会进行过流保护。超过了参数 1M11 所设置的电子热过载等级和脱扣时间，软起动装置将会进行过载保护。根据参数 1M14, 1M15 也将进行欠载保护。同时软起动也时时检测三相电流，当三相电流超出了 1M12 所设定的不平衡度时，也将进行相电流不平衡保护；保护的同时将会在界面上显示相应的故障类型，便于用户查找。起动需进行漏电检测则将 1M17 设置为 0，否则将其设置为 1。如果在使用过程中对电源相序没有要求，则将参数 1M18 设置为 0；否则将其设置为 1。

Users can set 1M10, the rated current of motor, according to the power of the motor, so as to

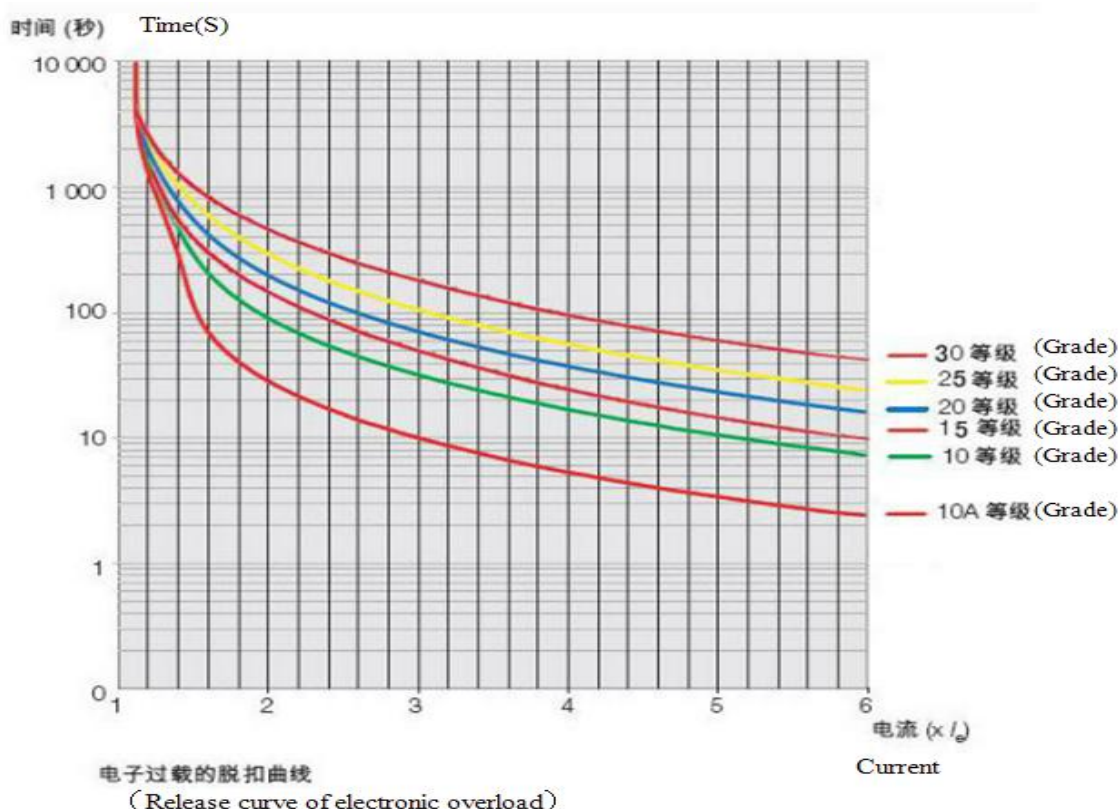

make the soft starter fit in well with the motor and protect the motor perfectly. The soft starter will carry out the over-current protection when the current exceeds the over-current protection value set by means of the parameter 1M13 in the process of running. The soft starter will carry out overload protection. The soft starter can also perform underload protection according to the parameter 1M14 and 1M15. In addition, the soft starter can inspect three-phase current at all times, and perform phase current imbalance protection when the three-phase current exceeds the imbalance degree set by means of 1M12. It will display the type of the fault in the interface while providing protection, which can facilitate the search of users. If the leakage detection is required by the start, 1M17 shall be set at 0 otherwise, 1M17 shall be set at 1. If the phase sequence of the power supply is not required during operation, the parameter 1M18 shall be set at 0; otherwise the parameter 1M18 shall be set at 1.

◆ 5.5.5 高级参数项 (Senior Parameters)

参数 Parameter	名称 Item	范围 Range	出厂值 Value
C00	语言选择 Language	0、中文 0、 Chinese 1、英文 1、 English	0
C01	显示选择 Display Options	0-电机额定电流 0-rate current of motor 1-平均电流 1-average current 2-L1 相电流 2-L1 current 3-L2 相电流 3-L2 current 4-L3 相电流 4-L3 current 5-模拟口值% 5-analogue input(%) 6-输出电压% 6-output voltage(%) 7-起动倒计时时间 7-start countdown 8-刹车倒计时时间 8-brake countdown	1
C02	Run/stop 控制 方式 Control mode of Run/stop	0-键盘运行禁止/485 通讯控制禁止 0-panel run disabled/485 collective control disabled 1-键盘运行允许/485 通讯控制禁止 1-panel run enabled/485 collective control disabled 2-键盘运行禁止/485 通讯控制允许 3-键盘运行允许/485 通讯控制允许 4-键盘点动允许/485 通讯控制禁止 5-键盘点动允许/485 通讯控制允许 6-键盘点动禁止/485 通讯控制允许 7-键盘点动禁止/485 通讯控制禁止	1

		2-panel run disabled/485 collective control enabled 3-panel run enabled/485 collective control enabled 4-panel jog enabled/485 collective control disabled 5-panel jog enabled/485 collective control enabled 6-panel jog disabled/485 collective control enabled 7-panel jog disabled/485 collective control disabled			
C03	数字输入口 D1 功能 Signal of digital input terminal D1	0-M2 参数选择 1-故障清除 2-点动 3-闭合接点宏控制 4-断开接点宏控制 5-急停控制输入 6-延时继电器控制输入	0-M2 parameter 1-fault reset 2-jog 3-closed contact macro control 4-break contact macro control 5-emergency input 6-time delay relay input		6
C04	数字输入口 D2 功能 Signal of digital input terminal D2	0-M2 参数选择 1-故障清除 2-点动 3-闭合接点宏控制 4-断开接点宏控制 5-急停控制输入 6-漏电闭锁保护输入	0-M2 parameter 1-fault reset 2-jog 3-closed contact macro control 4-break contact macro control 5-emergency input 6-electrical leakage locked input		6
C05	电机级数 Number of motor pole-pares	0-2 级数电机 3-8 级数电机 0-2pole-pares 3-8pole-pares	1-4 级数电机 4-Off 1-4pole-pares 4-Off	2-6 级数电机 2-6pole-pares	0
C06	模拟输入输出 Analogue input and output	0-0~20mA 模拟输入、输出（输入口正逻辑） 1-4~20mA 模拟输入、输出（输入口正逻辑） 2-0~20mA 模拟输入、4~20mA 模拟输出（输入口正逻辑） 3-4~20mA 模拟输入、0~20mA 模拟输出（输入口正逻辑） 4-0~20mA 模拟输入、输出（输入口负逻辑） 5-4~20mA 模拟输入、输出（输入口负逻辑） 6-0~20mA 模拟输入、4~20mA 模拟输出（输入口负逻辑） 7-4~20mA 模拟输入、0~20mA 模拟输出（输入口负逻辑）			1

		0-0~20mA analogue input and output(input logic plus) 1-4~20mA analogue input and output(input logic plus) 2-0~20mA analogue input, 4~20mA analogue output(input logic plus) 3-4~20mA analogue input, 0~20mA analogue output(input logic plus) 4-0~20mA analogue input and output(input logic plus) 5-4~20mA analogue input and output(input logic plus) 6-0~20mA analogue input, 4~20mA analogue output(input logic plus) 7-4~20mA analogue input, 0~20mA analogue output(input logic plus)		
C07	模拟输出方式 Type of analogue output	0-平均电流输出 1 (0-200Ie) % 1-平均电流输出 2 (0-400Ie) % 0-average current 1 (0-200Ie) % 1-average current 2 (0-400Ie) %		0
C08	宏控制选择功能 Function of macro control	0-无宏控制 1-RUN 宏控制延时 2-数字口 1 接点宏控制 3-数字口 2 接点宏控制 4-模拟输入宏控制	0-macro control disabled 1-RUN macro control delay 2-digital input 1 COM connected macro control 3-digital input 2 COM connected macro control 4-analogue input macro control	0
C09	宏控制延时 Macro control delay	0~250S		0
C10	模拟输入上限值 Top limit of analogue input	0~100%		80

C11	模拟输入下 限值 Lower limit of analogue input	0~100%		20
C12	输出继电器 K1 output signal of relay K1	0-全压输出 1-起动过程输出 2-软停过程输出 3-故障时输出 4-刹车时输出 5-运行过程中输出 6-可编程延时输出 7-漏电闭锁检测输出 8-欠载保护输出（不做为故障）	0-full voltage 1-motor starting 2-soft stopping 3-fault 4-braking 5-motor running 6-programmable time delay 7-electrical leakage detecting 8-under load protection（does not trip as a fault）	3
C13	K1 继电器延 时输出 K1 output delay	0~250S		0
C14	输出继电器 K3 output signal of relay K3	0-全压输出 1-起动过程输出 2-软停过程输出 3-故障时输出 4-刹车时输出 5-运行过程中输出 6-可编程延时输出 7-漏电闭锁检测输出 8-欠载保护输出（不做为故障）	0-full voltage 1-motor starting 2-soft stopping 3-fault 4-braking 5-motor running 6-programmable time delay 7-electrical leakage detecting 8-under load protection（does not trip as a fault）	7
C15	K3 继电器时 输出 K3 output delay	0~250S		0
C16	K2 继电器时	0~250S		20

	输出 K2 output delay			
C17	可编程定时 停车时间 Programmable operation timing	0-----999.9h(断开有效) 0-----999.9h(valid when run is disconnected with com)		0
C18	通信地址 Address for communication	1-32		1
C19	通信波特率 Time limit for starting	0-(600) 1-(1200) 2-(2400) 3-(4800) 4-(9600) 5-(19200)		4
C20	起动时间限制 Time limit for starting	0~120S		80
C21-C25	未定义参数 Not identified	-----		--
C26	密码设置 Password	0-----5535		--
C27	未定义参数 Not identified	-----		--
C28	未定义参数 Not identified	-----		--

5.5.6 参数项说明 (Explanation of senior parameters)

◆ 显示及起停控制参数 (Parameter for displaying and run/stop control) C00-C02

用户可根据实际需要进行语言种类的选择，现有中英文两种显示界面。在停止及运行过程中用户可通过 ΔV 键浏览实际的测量量（电机额定电流 I_e 、平均电流 I 、L1 相电流、L2 相电流、L3 相电流、模拟口值% A 、输出电压% U 、起动倒计时时间 t_1 、刹车倒计时时间 t_2 ）也可通过设

定参数 C01, 使软起动固定显示某一个测量量。参数 C02 用来选择软起动的起动/停止控制方式, 在任何一种起动/停止控制方式下, 用户均可通过接线端子进行起动/停止的控制。

Customer may choose the language for interface, and there are Chinese and English to select. Customer may scroll through the items that High Voltage Solid Soft Starter is monitoring by pressing button ΔV when it is in operation, include rate current of motor Ie, average current I, phase current L2, phase current L3, % of analogue input, % of output voltage, countdown to start t1 and countdown to brake t2. Moreover, customer can fix a item to display by setting up parameter C01. Parameter C02 are used to select control mode of run/stop. Customer may run or stop High Voltage Solid Soft Starter remotely through corresponding terminals no matter which control mode is selected.

◆ **数字口功能选择参数 (Function selection for digital input terminal) C03-C04**

- **M2 参数选择:** SEC-SPHMV 型软起动装置具有两套基本功能参数项, 用户可以通过闭合 D1/D2 与 COM 端实现对第二套基本功能项的选择 (D1/D2 设置为 M2 参数选择)。断开为 M1 套基本参数项。
- **M2 Parameter:** High Voltage Solid Soft Starter provides a second set of primary parameter which can be selected by connecting terminal D1/D2 and COM. (When D1/D2 is set M2 parameter.) Disconnect D1/D2 and COM to select M1 primary parameter.
- **故障清除:** 故障清除后若起动命令存在则软起动再次起动。
- **Fault reset:** High Voltage Solid Soft Starter will start motor again if a run command present when the fault is reset.
- **点动:** 软起动装置的点动功能可以通过键盘进行点动控制 (参数 C02 设置为键盘点动允许), RUN 键按下则软起动点动运行, RUN 键松开软起动装置停止; 也可通过数字口 D1/D2 进行点动控制, 数字口闭合软起动点动运行, 断开软起动装置停止。
- **Jog:** Customer may jog the motor through panel (when parameter C02 is set panel jog enabled). Keep pressing button RUN to jog motor and release the button to stop. This function can be realized by connecting or dis-connecting the digital input terminal D1/D2. Connect it to jog and dis-connect it to stop.
- **急停控制输入:** 当 D1/D2 设置为急停控制输入时, 通过断开 D1/D2 与 COM 端实现软起动装置急停车且 LDC 面板上显示急停界面。
- **Emergency input:** disconnect D1/D2 and COM to stop motor emergently when D1/D2 is set emergency input and LCD panel will display a emergency stop page.
- **延时继电器控制输入:** 当 D1 设置为延时继电器控制输入时, 相应的可编程继电器输出应设置为编程延时输出。当 D1 闭合时, 对应的继电器就会有输出 (继电器输出延时时间到)。

- **Time delay relay input:** the corresponding programmable relay should set programmable time delay output when D1 is set time delay relay input. The corresponding relay will put out a signal(when time delay of the relay is up) if D1 is connected.
- **漏电闭锁保护输入:** 当 D2 设置为漏电闭锁保护输入时, 相应的可编程继电器输出应设置为漏电闭锁检测输出, 且参数哦 1M17 应设置为 1.
- **Electrical leakage locked input:** the corresponding programmable relay should be set electrical leakage locked detecting output when D2 is set electrical leakage locked detecting input and parameter 1M17 should be set "1".
- 注: 闭合接点宏控制、断开接点宏控制与宏控制功能有关, 见宏控制功能说明。

Note: when macro control is selected, to connect or dis-connect the terminal is concerned with function of macro control. Please refer to function explanation of macro control.

◆ **模拟输入/输出选择参数(Analogue input/output selecting parameters)C06-C07**

用户可根据实际需要对模拟输入/输出量的范围及方式进行选择。

Customer may choose the range and signal type of analogue input/output according to particular application.

◆ **宏控制选择参数 (Macro control selecting parameters) C08-C11**

用户可以通过对宏的选择来实现对软起动装置自动起/停的控制。参数 C08 解析如下:

Customer may start or stop High Voltage Solid Soft Starter automatically by applying a macro(need to start the macro by button RUN on the panel). The following is explanation for parameter item C08.

- 无宏控制: 软起动的起动/停止不受宏的控制, 只与参与 C02 的设置及控制端子操作有关。
- Macro control disabled: starting or stopping of High Voltage Solid Soft Starter is not related to macro but is related to setting of parameter item C02 and connection of control terminals.
- RUN 宏控制: 在起动命令有效的情况下, 根据参数 C09 所设置的延时时间, 延时时间到开始运行。这里的延时至少针对于起动延时, 与宏操作无关。
- RUN macro control: start to run when time delay set by parameter C09 is up if the run command is valid. The time delay is only related to motor start but not to operation of marco.
- 数字口 1 及该单宏控制: 控制起动装置宏起/停 (起动命令有效后), 根据参数 C03 的设置: (设置为闭合接点宏控制: 数字口 D1 闭合, 且 C09 设置的延时时间到, 软起动装置启动。)如果在这个过程中数字口断开, 软起动停止, 界面上显示宏停。断开接点宏控制: 数字口 D1 断开, 且 C09 设置的延时时间到, 软起动起动。如果在这个过程中数字口闭合, 软起动停止, 界面上显示宏停。可通过断开数字口 D1 进行再次起动。

- **Digital 1 input terminal macro control:** to run or stop High Voltage Solid Soft Starter(when run command is valid). In accordance with setting of parameter C03:if it set COM dis-connected macro control: High Voltage Solid Soft Starter when digital input terminal D1 is connected and time delay set by parameter C09 is up. High Voltage Solid Soft Starter stops and macro stop is displayed on panel if the terminal is dis-connected during starting process. If it set COM connected macro control: High Voltage Solid Soft Starter when digital input terminal D1 is dis-connected and time delay set by parameter C09 is up. High Voltage Solid Soft Starter stop and macro stop is displayed on panel if the terminal is connected during starting process. Customer may dis-connect the terminal to start High Voltage Solid Soft Starter again.
- 数字口 2 接点宏控制：控制起动装置起/停（起动命令有效后），根据参数 C04 的设置：（设置为闭合接点宏控制：数字口 D2 闭合，且 C09 设置的延时时间到，软起动装置启动。）如果在这个过程中数字口断开，软起动停止，界面上显示宏停。断开接点宏控制：数字口 D2 断开，且 C09 设置的延时时间到，软起动启动。如果在这个过程中数字口闭合，软起动停止，界面上显示宏停。可通过断开数字口 D2 进行再次启动。
- **Digital 2 input terminal macro control:** to run or stop High Voltage Solid Soft Starter(when run command is valid). In accordance with setting of parameter C04:if it set COM dis-connected macro control: High Voltage Solid Soft Starter when digital input terminal D2 is connected and time delay set by parameter C09 is up. High Voltage Solid Soft Starter stops and macro stop is displayed on panel if the terminal is dis-connected during starting process. If it set COM connected macro control: High Voltage Solid Soft Starter when digital input terminal D2 is dis-connected and time delay set by parameter C09 is up. High Voltage Solid Soft Starter stop and macro stop is displayed on panel if the terminal is connected during starting process. Customer may dis-connect the terminal to start High Voltage Solid Soft Starter again.
- 模拟输入宏控制：使用模拟口宏控制功能，根据参数 C10、C11 所设置的模拟输入上限值，模拟输入下限值，高于上限则宏停车，低于下限启动（必须在起动命令有效后且 C09 设置的延时时间到。宏条件不满足，界面上显示宏停）。
- **Analogue input macro control:** to run or stop the motor according to top limit and lower limit of the analogue input set by parameter C10 and C11. High Voltage Solid Soft Starter will stop the motor when the top limit is exceeded and will run the motor when the lower limit is outstrip(only when the run command is valid and time delay set by parameter C09 is up. Macro stop will display on panel if the macro condition is not fulfilled).
- ◆ **继电器输出参数 (Parameter for relay output) C12-C16**

高压固态软起动装置的主控板上有三个继电器，其中有两个是可编程的，用户可根据实际需要设置为相应的输出，另有一个继电器的输出用来控制旁路接触器。

There are three relays on the main board of High Voltage Solid Soft Starter and two of them are programmable. Customer may set them according to requirement and the rest is designed to control the bypass contactor.

参数 C12、C13、C14、C15、C16: 用于设置继电器的输出方式及输出延时。

Parameter C12、C13、C14、C15、C16: to set function of output and output delay.

- 全压输出: 软起动装置输出电压达到额定电压时输出闭合(所设置的延时时间到)
- Full voltage: contacts when output voltage reaches rate voltage(and time delay is up).
- 起动过程输出: 软起动装置处于起动过程输出闭合(所设置延时时间到)。如果延时时间未到就已经全压, 则不进行输出。
- Starting: soft starter is starting motor(and time delay is up). The signal will not put out if voltage increases to full before the time delay is up.
- 软停过程输出: 软起动装置处于软停车时输出(所设置的延时时间到, 且其值必须小于参数 1M07 所设置的软停时间)。
- Soft stopping: the signal put out when soft starter is ramping down(and time delay is up and it is less than the soft stopping time set by parameter item 1M07).
- 故障时输出: 软起动装置检测到故障时输出闭合(所设置的延时时间到)。
- Fault: put out the signal when a fault is detected by soft starter(and time delay is up).
- 刹车时输出: 软起动装置处于刹车时输出(所设置的延时时间到, 且其值必须小于参数 1M09 所设置的刹车时间)。
- Breaking :put out the signal when soft starter is braking(and time delay is up and it is less than the breaking time set by parameter item 1M09).
- 运行过程输出: 在运行的整个过程输出(所设置的延时时间到)。
- Running : put out the signal during motor running(and time delay is up).
- 可编程延时输出: 参数 C03 必须设置为延时继电器控制输入, 相当于是一个内置延时继电器。
- Programmable time delay:parameter C03 must set time delay relay input which is regard as a time delay relay.
- 欠载保护输出(不做为故障): 检测到欠载时输出闭合(所设置的延时时间到)但不将其作为故障。
- Under load protection(does not trip as a fault): the signal is put out when under load is detected(and preset time delay is up) but is not treated as a fault.

◆ 定时停车参数 (Parameter for operation timing) C17

需要设定该参数是, 最小设定量为 0.1h, 指当软起动装置运行后, 在指定时间到后按照设定的停车方式运行停车(采用双节点接线控制方式时有效)。

Minimum set value of this parameter is 0.1h if it is needed. The parameter means High Voltage Solid Soft Starter will stop motor within the time in preset mode after motor starts up.(Valid when dual-node control mode is applied).

- ◆ 通信及密码保护参数（Parameters for communication and password lockout）C18-C19、C26 在进行网络通讯时，可连接 32 台设备，并可通过 LCD 显示屏查看当前的通讯地址。参数 C26 进行功能项的密码设置，实现设置参数的密码保护。

32 High Voltage Solid Soft Starter can be connected to the net when collective is required and customer can read preset address through LCD pane. Parameter item C26 is to set password to parameter modification so that the setting are lockout.

5.5.7 显示记录参数项（Parameters for displaying and recording）

参数 Parameter	名称 Item	范围 Range	出厂值 Value
N00	软起额定电流 Rate current of soft starter	不可修改 Can not be modified	---
N01	电流测量校正 Rectification to current measuring	不可修改 Can not be modified	---
N02	电流显示精度 Precision of displaying current	不可修改 Can not be modified	---
N03	累计运行次数记录 Total operation	不可修改 Can not be modified	---
N04	累计运行时间记录 Total operating time	不可修改 Can not be modified	---
N05-N14	制造商参数 Parameter for manufacturer	不可修改 Can not be modified	---
N15	故障次数记录 Fault record NO.	不可修改 Can not be modified	---
N16-N30	故障历史记录 Fault history	不可修改 Can not be modified	---



显示记录参数项记录软起动装置的工作及状态信息，此功能项用户不可修改。

Display and record parameters and record the operation and status information of soft starter. This function should not be modified.

第六章 维护及故障排除

Section 6 Maintenance and Troubleshooting

SEC-SPHMV 系列设计为免维护产品。然而和其它电子设备一样，这个产品应定期检查是否有尘土污染、受潮及工业生产环境污染。严重的污染会引起高压放电及影响 SCR 的散热器散热。

SEC-SPHMV series products are designed to be free of maintenance. Like electric equipment, this equipment should be regularly checked for dust pollution, damp and environmental pollution resulted from industrial production. Serious pollution may result in high voltage discharge and effect the heat dissipation of SCR's cooler.

6.1 故障分析(Fault analysis)

当故障发生时，LCD\触摸屏上将会显示相应的故障信息。要在清除故障后再重新启动电机。如果在使用正确的操作方法和编程处理后仍无法排除故障，请与生产厂家联系。

When a fault occurs, the corresponding fault information will be displayed on LCD touch screen. The motor should be restarted after the fault is cleared.If the fault still can not be cleared using correct operating method and program processing, please contact the manufacturer.

6.2 故障代码(Fault code)

软起动装置有多种保护功能，当软起动装置保护功能动作时，软起动装置立即停机，LCD 液晶显示屏\ 触摸屏\装置面板上将显示当前故障信息。用户可根据故障内容进行故障分析。

The soft starter has multiple protective functions. When the protective function act, the soft starter will stop immediately and the current fault information will be displayed on LCD screen, touch screen and panel. Users can analyze clear faults according to fault information.

故障代码 Fault code	故障名称 Fault	故障原因 Cause	处理方法 Troubleshooting
01	主电源缺相 Primary power phase loss	在起动或运行中缺相? Phase loss in starting or operation	检查三相电源是否可靠 Check the reliability of three-phase power
02	相序错误 Phase sequence error	相序接反 Phase sequence reservedly connected	调整相序或设置为不检测相序 Adjust phase sequence or set phase sequence free of check.
03	参数丢失 Parameters lost	设定参数丢失 Set parameter lost	检查各功能项设置并重新设定 Check functions setting and reset

05	运行过流 Over-current in operation	负载突然加重 Load suddenly becomes heavy 负载波动太大 Load variation is too large	T 调整负载运行状况 Adjust load running state 调整 1M13 项 Adjust 1M13
07	相电路不平衡 Unbalanced phase current	缺相或相电压不平衡 Phase loss or phase voltage is unbalanced	调整 1M12 项 Adjust 1M12
08	可控硅过热 Thyristor overheat	内部散热器过热 机器通风不畅 Internal cooler is overheat The starter is not well ventilated	检查风机是否可靠工作 减低起动频度 检查控制电源电压是否过低 Check the qualification fo fan Lower start frequency Check if the control power voltage is too low
09	内部禁止 Internal prohibition	违反操作规程 Violate operating instruction	确认操作规程 Ensure operating instruction
10	起动超时 Start timeout	负载过重起动时间太短 限流幅制过小 Overburdened and start time is too short Current limiting amplitude is too small	调整斜坡时间 1M04 时间项 调整电流限幅制 1M05 Adjust ramp time 1M04 Adjust current limiting amplitude 1M05
--	过压保护 Over-voltage protection	主回路电源电压高于设定值 Power voltage of major loop is higher than set value	调整过压保护值 检查主电源电压是否过高 Adjust over-voltage protection value Check if primary prower voltage if too high
--	欠压保护 Under-voltage protection	主回路电源电压低于设定值 Power voltage of major loop	调整欠压保护值 检查主电源电压是否过低 Adjust Under-voltage

		is lower than set value	protection value Check if primary voltage is too low.
--	接地保护 Ground protection	接地电流大于允许值 Ground current is larger than allowed value	检查是否存在接地电流 Check if there is ground current
--	起动过频保护 Frequent start protection	起动过频 Frequent start	降低起动频次 Reduce start frequent
13	电子热过载 Electronic thermal overload	大电流持续时间过长是否超载运行 The duration of heavy current is too long Overload operation or not.	检查功能项电机电流设置是否有误 是否超载 Check if motor current is wrongly set. Overload or not
14	SCR 异常 Abnormal SCR	SCR 工作不正常 软起动装置输出缺相 SCR works abnormally Output phase loss for soft starter	检查 SCR 是否损坏 检查软起动装置输入输出是否缺相 Check whether SCR is damaged Check whether input or output of soft starter lacks phase

6.3 故障记录 (*Fault history*)

起动装置最多可记录最近 15 次故障信息，供用户以后分析使用。

This starter can at most record the recent 15 fault information for users.

6.4 故障清除 (*Troubleshooting*)

故障具有记忆性，故在故障排除后，通过按键 STOP（长按 4 秒以上）、外接清除故障输入（D1 或 D2 多功能输入）端子或者通过断开 AC220V 控制电源进行故障复位，使装置恢复到起动准备状态。

As fault has memory, after fault is cleared, you can reset fault through pressing button “STOP” for above 4 seconds, external fault clearance input terminal(D1 or D2 multifunction input) or cutting off AC220V control power to restore the starter to the state of ready to start.

6.5 日常维护 (Maintenance)

工业现场需定期打扫，减少周围环境粉尘颗粒。

The working field should be regularly cleaned to reduce dust in ambient environment.

SEC-SPHMV 系列高压软起装置应定期对清理高、低压仓室进行清理，清理时可用毛刷或吹风设备对仓室内的粉尘颗粒整体进行清理（周期小于 20 天）。

The low and high voltage bins of SEC-SPHMV series high voltage soft starter should be regularly cleaned. It is necessary to use a brush or blower to remove dust inside bin(period less than 20 days).

晶闸管阀组的清理也很关键，清理时可用功率较大的吹风设备从阀体上端，从上向下进行吹风清理，清理完毕打扫现场（周期小于 6 个月）。

It is also important to clean thyristor valve block. A blower with big power can be used to clean the valve block by blowing from up to down. Clean the field after blowing the thyristor valve block(period less than 6 months).

如果现场环境潮湿应定期对 SEC-SPHMV 系列高压软起装置进行除湿，确保设备安全正常工作（周期根据现场情况决定）。

To ensure the normal operation, SEC-SPHMV series high voltage soft starter should be regularly dehumidified if the working field is wet.(period is depended on the circumstance)

考虑工业现场设备起动有震动等因素，应对 SEC-SPHMV 系列高压软起装置的二次控制接线进行定期检查，查看连接线头是否松动或脱落，将松动或脱落的接点拧紧（周期 3 个月）。

Considering that there is shake in working field when the soft starter is started, the secondary control wiring of SEC-SPHMV high voltage soft starter should be regularly checked to examine whether the connecting terminal is loose. If yes, tighten the loose connecting terminal.(3 months as a period)

第七章 附加说明

Section 7 Additional Information

7.1 订货须知 (*Order information*)

订货时请提供下列资料:

Following information is required to provided in the order.

- ◆ 上端电源状况
- ◆ 电动机型号、额定电压、额定电流、额定功率、额定转速
- ◆ 电动机拖动负载类型 (风机、水泵等)
- ◆ 设备进出线方式
- ◆ 设备使用环境
- ◆ 若用户有其它要求请与我公司联系
- ◆ *Upper power condition*
- ◆ *Motor model, rated voltage, rated current, rated power and rated speed*
- ◆ *Motor drive load types(wind machine, water pump, etc.)*
- ◆ *Equipment incoming / outgoing cables*
- ◆ *Operating environment*
- ◆ *For other requirements, please contact us.*

接线原理图 (schematic diagram of wiring)

- 本公司保留产品设计和变更的权利，恕不另行通知
- 本产品说明书中图片与实物有差异，以实物为准
- The company keeps the right for product design and change, which are subject to change without prior notice.
- There maybe difference between pictures in this manual and physical object, and physical object shall prevail.

公司名称：襄阳赛克斯电气股份有限公司

公司地址：湖北省襄阳市人民西路 19 号

邮编：441000

电话：0710—2399677 / 2399678

传真：0710-2399676

邮箱：secdq@sina.com

Company name: Xiangyang Success Electric CO., LTD

Company Add: the people street of the 19th West, hubei province, China

Zip Code: 441000

Tel : 0710—2399677 2399678

Fax : 0710-2399676

Email: secdq@sina.com